

---

## CHT-NMOS40XX - DATASHEET

Version: 03.9  
26-Mar-15  
(Last Modification Date)

---

## High-Temperature, 40V N-channel Power MOSFET

---

### General description

The CHT-NMOS-40xx is a high voltage N-channel power MOSFET family designed to achieve high performance in an extremely wide temperature range: typical operation temperature goes from -55°C to 225°C.

CHT-NMOS40 parts sustain the highest temperatures while keeping leakage currents low.

### Markets

- Aeronautics & aerospace,
- Oil & Gas,
- Industrial,
- Automotive.

### Features

- Specified from -55 to +225°C (Tj)
- Drain voltage up to 40V
- Typical output current:
  - CHT-NMOS-4005: 5A @ 25°C
  - CHT-NMOS-4010: 10A @ 25°C
  - CHT-NMOS-4020: 20A @ 25°C
- $R_{DS(on)}$ :
  - CHT-NMOS-4005: 0.65Ω @ 225°C
  - CHT-NMOS-4010: 0.36Ω @ 225°C
  - CHT-NMOS-4020: 0.25Ω @ 225°C
- VGS = 0V to +5V
- Reverse ESD diode between gate and source.
- Validated at 225°C for 1000 hours (and still on-going)
- Available in TO254 package

---

### Package configurations<sup>1</sup>

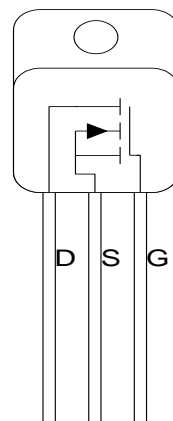

**TO254 (Top view) (Case floating)**

<sup>1</sup> Other packages available upon request.

### Absolute Maximum Ratings

Gate-to-Source voltage $V_{GS}$	-0.5V to 5.5V
Pulsed drain current $I_{DS}$ ( $T_{pulse} \leq 2\mu s$ ):	
• CHT-NMOS4005:	7A @ -55°C 6A @ 25°C 4A @ 225°C
• CHT-NMOS4010:	14A @ -55°C 12A @ 25°C 8A @ 225°C
• CHT-NMOS4020:	28A @ -55°C 22A @ 25°C 16A @ 225°C
Power dissipation $T_c=25^\circ C$	
• CHT-NMOS4005:	40W
• CHT-NMOS4010:	66W
• CHT-NMOS4020:	100W
DC drain current ( $V_{GS}=5V$ )	
• CHT-NMOS4005:	5A
• CHT-NMOS4010:	10A
• CHT-NMOS4020:	20A
Junction temperature $T_j$	300°C

### ESD Rating

Human Body Model	2kV
------------------	-----

### Operating Conditions

Gate-to-Source voltage $V_{GS}$	0V to 5V
Drain-to-Source voltage $V_{DS}$	0V to 40V
DC drain current ( $V_{GS}=5V$ )( $T_C=175^\circ C$ )	
• CHT-NMOS4005:	4A
• CHT-NMOS4010:	6.8A
• CHT-NMOS4020:	10A
Junction temperature	-55°C to +225°C
See Thermal characteristics for power derating with temperature	

*Stresses above those listed in "Absolute Maximum Ratings" may cause permanent damage to the device. This is a stress only rating and operation of the device at these or any other conditions above those indicated in the operational sections of this specification is not implied. Frequent or extended exposure to absolute maximum rating conditions or above may affect device reliability.*

## Electrical characteristics of CHT-NMOS4005

### DC Characteristics

Unless otherwise stated,  $T_j = 25^\circ\text{C}$ . **Bold** figures point out values valid over the whole temperature range ( $T_j = -55^\circ\text{C}$  to  $+225^\circ\text{C}$ ).

Parameter	Symbol	Condition	Min	Typ	Max	Unit
Threshold voltage	$V_{TH}$	$V_{DS} = 50\text{mV}$	<b>0.85</b>	1.6	<b>1.95</b>	V
Drain cut-off current	$I_{DSS}$	$V_{GS} = 0\text{V}, V_{DS} = 40\text{V}, T_j = 25^\circ\text{C}$		15		nA
		$V_{GS} = 0\text{V}, V_{DS} = 40\text{V}, T_j = 225^\circ\text{C}$		8		uA
Gate leakage current <sup>1</sup>	$I_{GSS}$	$V_{GS} = 5\text{V}, V_{DS} = 50\text{mV}, T_j = 25^\circ\text{C}$		189		pA
		$V_{GS} = 5\text{V}, V_{DS} = 50\text{mV}, T_j = 225^\circ\text{C}$		72.1		nA
Static drain-to-source resistance	$R_{DS(on)}$	$V_{GS} = 5\text{V}, V_{DS} = 50\text{mV}, T_j = -55^\circ\text{C}$		0.3		$\Omega$
		$V_{GS} = 5\text{V}, V_{DS} = 50\text{mV}, T_j = 25^\circ\text{C}$		0.38		$\Omega$
		$V_{GS} = 5\text{V}, V_{DS} = 50\text{mV}, T_j = 225^\circ\text{C}$		0.65		$\Omega$
Breakdown drain-to-source voltage <sup>2</sup>	$V_{BRDS}$	$V_{GS} = 0\text{V}$	<b>40</b>			V

### Dynamic Characteristics

Unless otherwise stated,  $T_j = 25^\circ\text{C}$ . **Bold** figures point out values valid over the whole temperature range ( $T_j = -55^\circ\text{C}$  to  $+225^\circ\text{C}$ ).

Parameter	Symbol	Condition	Min	Typ	Max	Unit
Input capacitance	$C_{ISS}$	$V_{GS} = 0V_{DC}, DS$ shorted		370		pF
Output capacitance	$C_{OSS}$	$V_{GS} = 0V_{DC}, V_{DS} = 40V_{DC}$		50		pF
Feedback capacitance	$C_{RSS}$	$V_{GS} = 0V_{DC}, V_{DS} = 40V_{DC}$		21		pF
Gate to Source Charge	$Q_{GS}$	$V_{GS} = [0 \rightarrow 5]V; VD = 40V$		3.8		nC

### Switching Characteristics

Unless otherwise stated,  $T_j = 25^\circ\text{C}$ . **Bold** figures point out values valid over the whole temperature range ( $T_j = -55^\circ\text{C}$  to  $+225^\circ\text{C}$ ).

Parameter	Symbol	Condition	Min	Typ	Max	Unit
Turn-on delay time	$T_{d(ON)}$	$V_{DS} = 20V, V_{GS} = 5V$ 2 $\mu\text{s}$ pulse, $R_G = 2.7\Omega, R_D = 8.2\Omega$		<b>30</b>		ns
Rise time	$T_r$	$V_{DS} = 20V, V_{GS} = 5V$ 2 $\mu\text{s}$ pulse, $R_G = 2.7\Omega, R_D = 8.2\Omega$		<b>50</b>		ns
Turn-off delay time	$T_{d(OFF)}$	$V_{DS} = 20V, V_{GS} = 5V$ 2 $\mu\text{s}$ pulse, $R_G = 2.7\Omega, R_D = 8.2\Omega$		<b>35</b>		ns
Fall time	$T_f$	$V_{DS} = 20V, V_{GS} = 5V$ 2 $\mu\text{s}$ pulse, $R_G = 2.7\Omega, R_D = 8.2\Omega$		<b>15</b>		ns
Drain current	$I_D$	$V_{DS} = 40V, V_{GS} = 5V$ 2 $\mu\text{s}$ pulse, $-55^\circ\text{C}$		6.6		A
		$V_{DS} = 40V, V_{GS} = 5V$ 2 $\mu\text{s}$ pulse, $25^\circ\text{C}$		5.7		A
		$V_{DS} = 40V, V_{GS} = 5V$ 2 $\mu\text{s}$ pulse, $225^\circ\text{C}$		3.9		A

<sup>1</sup> Includes ESD diode leakage current.

<sup>2</sup> Voltage for which the cut-off current evolution versus  $V_{DS}$  becomes exponential.

## Electrical characteristics of CHT-NMOS4010

### DC Characteristics

Unless otherwise stated,  $T_j = 25^\circ\text{C}$ . **Bold** figures point out values valid over the whole temperature range ( $T_j = -55^\circ\text{C}$  to  $+225^\circ\text{C}$ ).

Parameter	Symbol	Condition	Min	Typ	Max	Unit
Threshold voltage	$V_{TH}$	$V_{DS} = 50\text{mV}$	<b>0.85</b>	1.55	<b>1.95</b>	V
Drain cut-off current	$I_{DSS}$	$V_{GS} = 0\text{V}, V_{DS} = 40\text{V}, T_j = 25^\circ\text{C}$		25		nA
		$V_{GS} = 0\text{V}, V_{DS} = 40\text{V}, T_j = 225^\circ\text{C}$		10		$\mu\text{A}$
Gate leakage current <sup>3</sup>	$I_{GSS}$	$V_{GS} = 5\text{V}, V_{DS} = 50\text{mV}, T_j = 25^\circ\text{C}$		204		$\mu\text{A}$
		$V_{GS} = 5\text{V}, V_{DS} = 50\text{mV}, T_j = 225^\circ\text{C}$		294		nA
Static drain-to-source resistance	$R_{DS(on)}$	$V_{GS} = 5\text{V}, V_{DS} = 50\text{mV}, T_j = -55^\circ\text{C}$		0.16		$\Omega$
		$V_{GS} = 5\text{V}, V_{DS} = 50\text{mV}, T_j = 25^\circ\text{C}$		0.2		$\Omega$
		$V_{GS} = 5\text{V}, V_{DS} = 50\text{mV}, T_j = 225^\circ\text{C}$		0.36		$\Omega$
Breakdown drain-to-source voltage <sup>4</sup>	$V_{BRDS}$	$V_{GS} = 0\text{V}$	<b>40</b>			V

### Dynamic Characteristics

Unless otherwise stated,  $T_j = 25^\circ\text{C}$ . **Bold** figures point out values valid over the whole temperature range ( $T_j = -55^\circ\text{C}$  to  $+225^\circ\text{C}$ ).

Parameter	Symbol	Condition	Min	Typ	Max	Unit
Input capacitance	$C_{ISS}$	$V_{GS} = 0\text{V}_{DC}$ , DS shorted		720		pF
Output capacitance	$C_{OSS}$	$V_{GS} = 0\text{V}_{DC}$ , $V_{DS} = 80\text{V}_{DC}$		93		pF
Feedback capacitance	$C_{RSS}$	$V_{GS} = 0\text{V}_{DC}$ , $V_{DS} = 80\text{V}_{DC}$		42		pF
Gate to Source Charge	$Q_{GS}$	$V_{GS} = [0 \rightarrow 5]\text{V}$ ; $V_D = 40\text{V}$		7.6		nC

### Switching Characteristics

Unless otherwise stated,  $T_j = 25^\circ\text{C}$ . **Bold** figures point out values valid over the whole temperature range ( $T_j = -55^\circ\text{C}$  to  $+225^\circ\text{C}$ ).

Parameter	Symbol	Condition	Min	Typ	Max	Unit
Turn-on delay time	$T_{d(ON)}$	$V_{DS} = 20\text{V}, V_{GS} = 5\text{V}$ 2 $\mu\text{s}$ pulse, $R_G = 2.7\Omega, R_D = 8.2\Omega$		<b>35</b>		ns
Rise time	$T_r$	$V_{DS} = 20\text{V}, V_{GS} = 5\text{V}$ 2 $\mu\text{s}$ pulse, $R_G = 2.7\Omega, R_D = 8.2\Omega$		<b>60</b>		ns
Turn-off delay time	$T_{d(OFF)}$	$V_{DS} = 20\text{V}, V_{GS} = 5\text{V}$ 2 $\mu\text{s}$ pulse, $R_G = 2.7\Omega, R_D = 8.2\Omega$		<b>53</b>		ns
Fall time	$T_f$	$V_{DS} = 20\text{V}, V_{GS} = 5\text{V}$ 2 $\mu\text{s}$ pulse, $R_G = 2.7\Omega, R_D = 8.2\Omega$		<b>24</b>		ns
Drain current	$I_D$	$V_{DS} = 40\text{V}, V_{GS} = 5\text{V}$ 2 $\mu\text{s}$ pulse, $-55^\circ\text{C}$		12.8		A
		$V_{DS} = 40\text{V}, V_{GS} = 5\text{V}$ 2 $\mu\text{s}$ pulse, $25^\circ\text{C}$		11.2		A
		$V_{DS} = 40\text{V}, V_{GS} = 5\text{V}$ 2 $\mu\text{s}$ pulse, $225^\circ\text{C}$		7.6		A

<sup>3</sup> Includes ESD diode leakage current.

<sup>4</sup> Voltage for which the cut-off current evolution versus  $V_{DS}$  becomes exponential.

## Electrical characteristics of CHT-NMOS4020

### DC Characteristics

Unless otherwise stated,  $T_j = 25^\circ\text{C}$ . **Bold** figures point out values valid over the whole temperature range ( $T_j = -55^\circ\text{C}$  to  $+225^\circ\text{C}$ ).

Parameter	Symbol	Condition	Min	Typ	Max	Unit
Threshold voltage	$V_{TH}$	$V_{DS} = 50\text{mV}$	<b>0.85</b>	1.6	<b>1.95</b>	V
Drain cut-off current	$I_{DSS}$	$V_{GS} = 0\text{V}, V_{DS} = 40\text{V}, T_j = 25^\circ\text{C}$		40		nA
		$V_{GS} = 0\text{V}, V_{DS} = 40\text{V}, T_j = 225^\circ\text{C}$		20		uA
Gate leakage current <sup>5</sup>	$I_{GSS}$	$V_{GS} = 5\text{V}, V_{DS} = 50\text{mV}, T_j = 25^\circ\text{C}$		TBD		nA
		$V_{GS} = 5\text{V}, V_{DS} = 50\text{mV}, T_j = 225^\circ\text{C}$		TBD		uA
Static drain-to-source resistance	$R_{DS(on)}$	$V_{GS} = 5\text{V}, V_{DS} = 50\text{mV}, T_j = -55^\circ\text{C}$		0.1		$\Omega$
		$V_{GS} = 5\text{V}, V_{DS} = 50\text{mV}, T_j = 25^\circ\text{C}$		0.12		$\Omega$
		$V_{GS} = 5\text{V}, V_{DS} = 50\text{mV}, T_j = 225^\circ\text{C}$		0.25		$\Omega$
Breakdown drain-to-source voltage <sup>6</sup>	$V_{BRDS}$	$V_{GS} = 0\text{V}$	<b>40</b>			V

### Dynamic Characteristics

Unless otherwise stated,  $T_j = 25^\circ\text{C}$ . **Bold** figures point out values valid over the whole temperature range ( $T_j = -55^\circ\text{C}$  to  $+225^\circ\text{C}$ ).

Parameter	Symbol	Condition	Min	Typ	Max	Unit
Input capacitance	$C_{ISS}$	$V_{GS} = 0\text{V}_{DC}, DS$ shorted		<b>1.84</b>		nF
Output capacitance	$C_{OSS}$	$V_{GS} = 0\text{V}_{DC}, V_{DS} = 80\text{V}_{DC}$		<b>TBD</b>		pF
Feedback capacitance	$C_{RSS}$	$V_{GS} = 0\text{V}_{DC}, V_{DS} = 80\text{V}_{DC}$		<b>TBD</b>		pF
Gate to Source Charge	$Q_{GS}$	$V_{GS} = [0 \rightarrow 5]\text{V}; VD = 40\text{V}$		15.2		nC

### Switching Characteristics

Unless otherwise stated,  $T_j = 25^\circ\text{C}$ . **Bold** figures point out values valid over the whole temperature range ( $T_j = -55^\circ\text{C}$  to  $+225^\circ\text{C}$ ).

Parameter	Symbol	Condition	Min	Typ	Max	Unit
Turn-on delay time	$T_{d(ON)}$	$V_{DS} = 20\text{V}, V_{GS} = 5\text{V}$ 2 $\mu\text{s}$ pulse, $R_G = 2.7\Omega, R_D = 8.2\Omega$		TBD		ns
Rise time	$T_r$	$V_{DS} = 20\text{V}, V_{GS} = 5\text{V}$ 2 $\mu\text{s}$ pulse, $R_G = 2.7\Omega, R_D = 8.2\Omega$		TBD		ns
Turn-off delay time	$T_{d(OFF)}$	$V_{DS} = 20\text{V}, V_{GS} = 5\text{V}$ 2 $\mu\text{s}$ pulse, $R_G = 2.7\Omega, R_D = 8.2\Omega$		TBD		ns
Fall time	$T_f$	$V_{DS} = 20\text{V}, V_{GS} = 5\text{V}$ 2 $\mu\text{s}$ pulse, $R_G = 2.7\Omega, R_D = 8.2\Omega$		TBD		ns
Drain current	$I_D$	$V_{DS} = 40\text{V}, V_{GS} = 5\text{V}$ 2 $\mu\text{s}$ pulse, $-55^\circ\text{C}$		28		A
		$V_{DS} = 40\text{V}, V_{GS} = 5\text{V}$ 2 $\mu\text{s}$ pulse, $25^\circ\text{C}$		22		A
		$V_{DS} = 40\text{V}, V_{GS} = 5\text{V}$ 2 $\mu\text{s}$ pulse, $225^\circ\text{C}$		16		A

### Thermal Characteristics

Parameter	Symbol	Condition	Min	Typ	Max	Unit
Thermal resistance (junction to case, TO-254 package) CHT-NMOS4005 CHT-NMOS4010 CHT-NMOS4020	$\Theta_{JC}$			5 3 2		$^\circ\text{C/W}$

<sup>5</sup> Includes ESD diode leakage current.

<sup>6</sup> Voltage for which the cut-off current evolution versus  $V_{DS}$  becomes exponential.

## Typical Performance Characteristics of CHT-NMOS4005

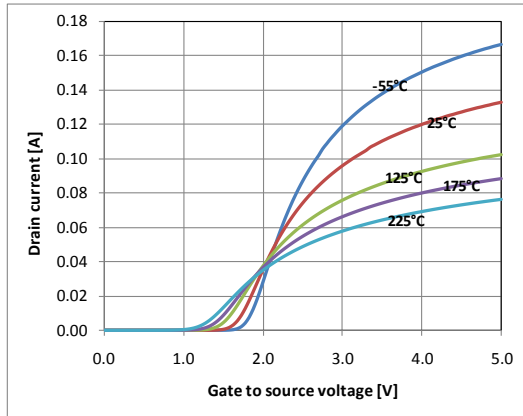
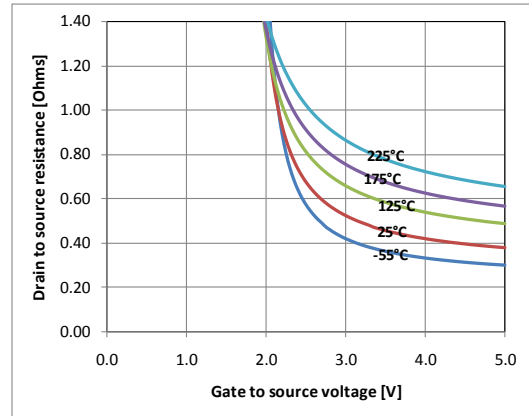
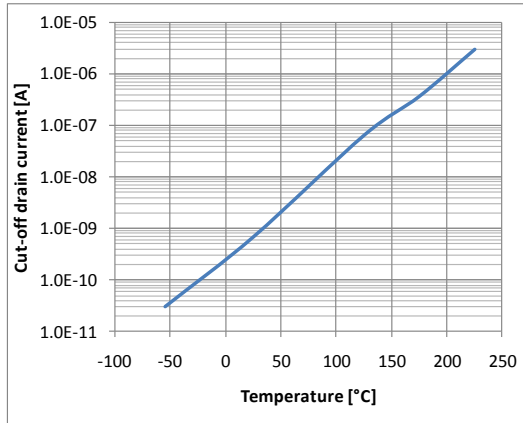
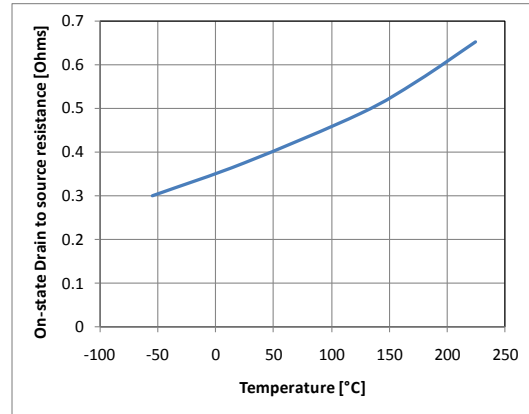
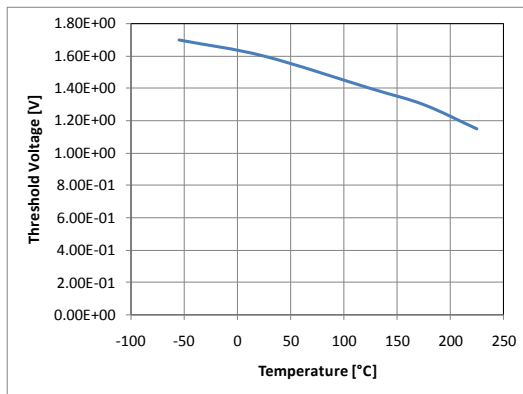
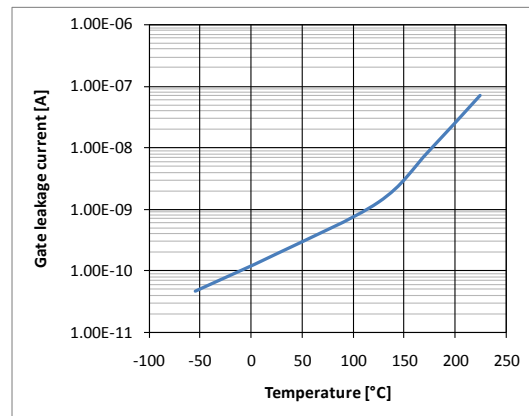

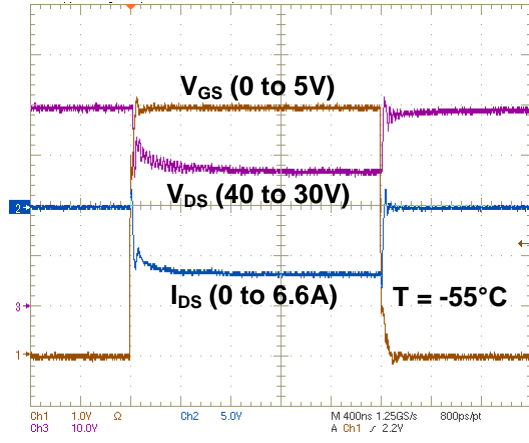
**Drain current vs. gate voltage ( $V_D = 50mV$ )**

**Drain source resistance vs. Drain source voltage ( $V_D = 50mV$ )**

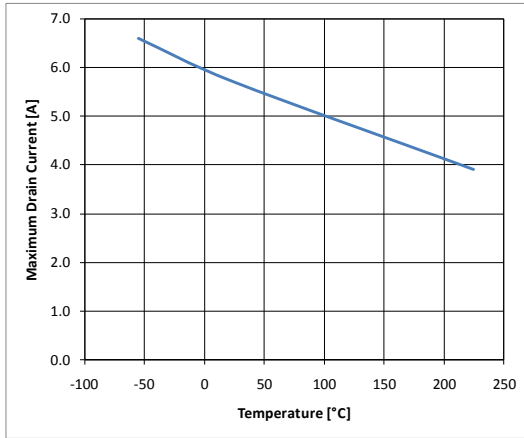
**Cut-off current vs. temperature ( $V_G = 0V, V_D = 40V$ )**

**On-state drain source resistance vs. temperature ( $V_G = 5V, V_D = 50mV$ )**

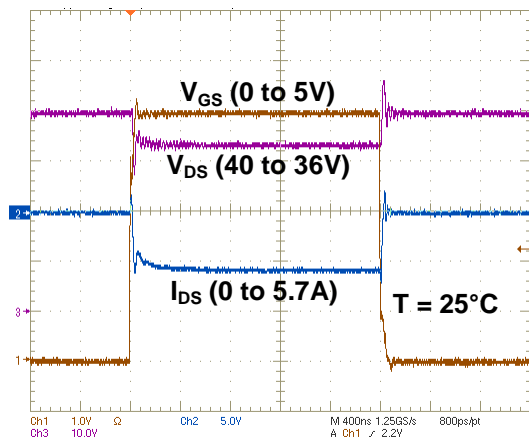
**Threshold voltage vs. temperature**

**Gate and ESD diode leakage current vs. temperature ( $V_G = 5V, V_D = 50mV$ )**



Maximum drain current pulse test (T = -55°C)



Peak drain current vs. temperature (V<sub>G</sub> = 5V, V<sub>D</sub> = 40V)



Maximum drain current pulse test (T = 25°C)

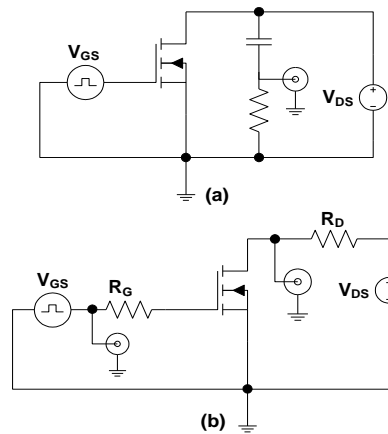

(a) I<sub>D</sub><sup>MAX</sup> measurement scheme R=1Ω, C=100μF, Compliance (V<sub>DS</sub>=40V)=20mA (b) Timing measurement scheme R<sub>G</sub>=2.7Ω, R<sub>D</sub>=8.2Ω, V<sub>DS</sub>=20V

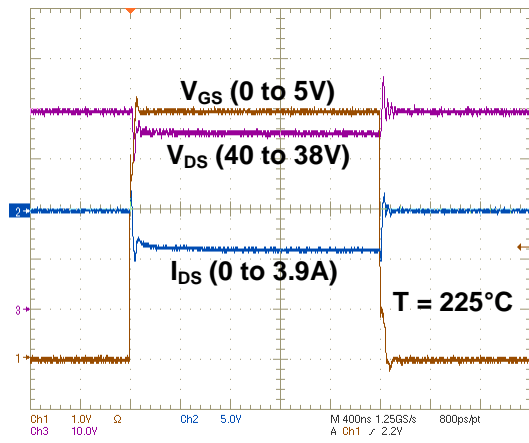

Maximum drain current pulse test (T = 225°C)

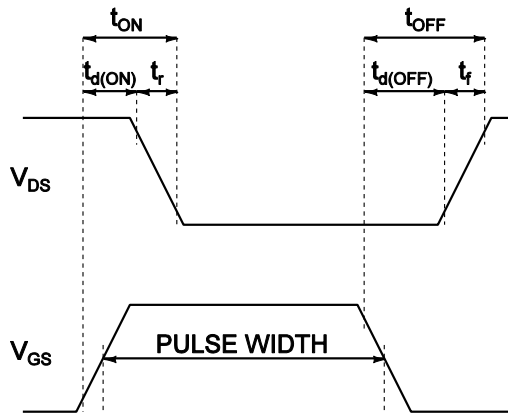

Timing definition diagram

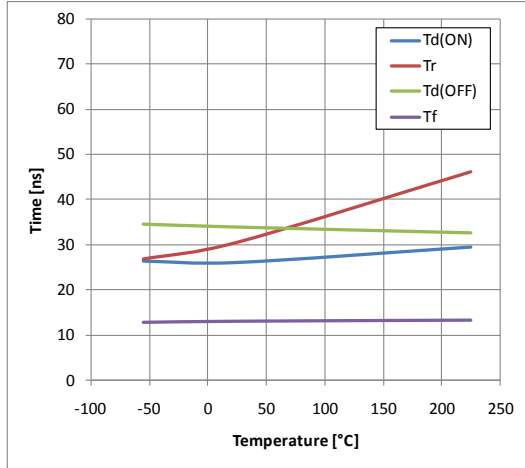
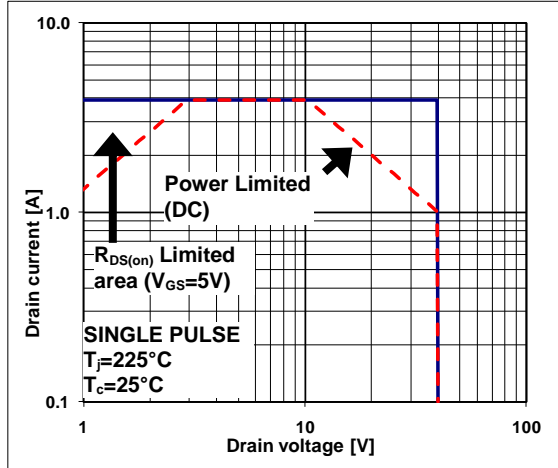

**Timing parameters versus temperature**

**Forward bias safe operating area.**

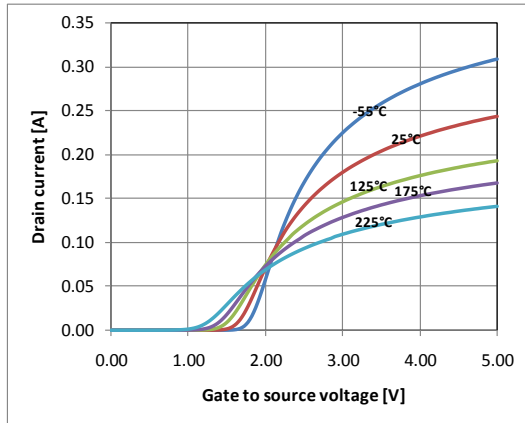

## Typical Performance Characteristics of CHT-NMOS4010

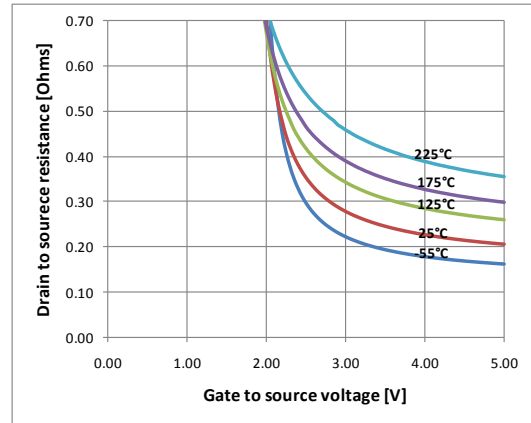

Drain current vs. Gate-source voltage ( $V_D=50mV$ ).



Drain source resistance vs. Gate-source voltage ( $V_D=50mV$ ).

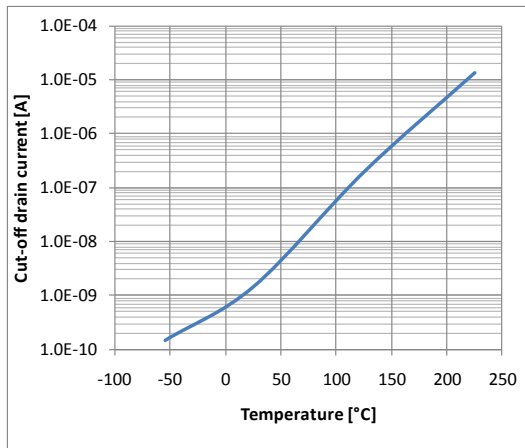

Cut-off current vs. temperature ( $V_G=0V$ ,  $V_D=40V$ ).

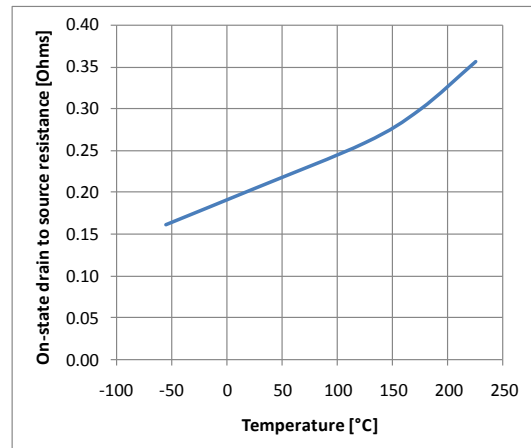

On-state drain source resistance vs. temperature ( $V_G=5V$ ,  $V_D=50mV$ ).

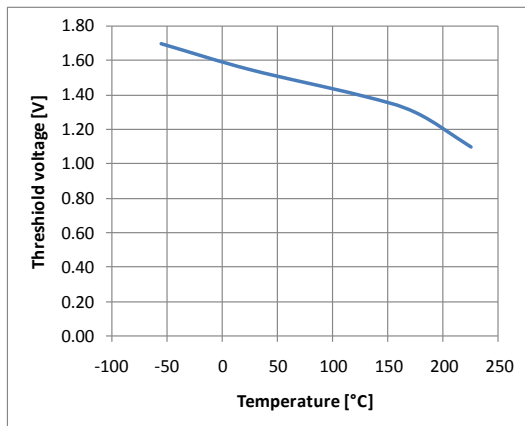

Threshold voltage vs. temperature.

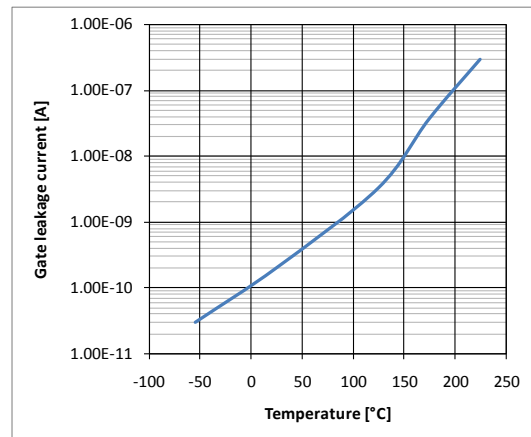

Gate and ESD diode leakage current vs. temperature ( $V_G=5V$ ,  $V_D=50mV$ ).

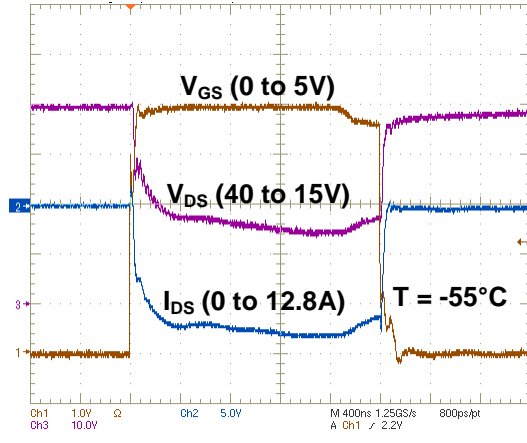
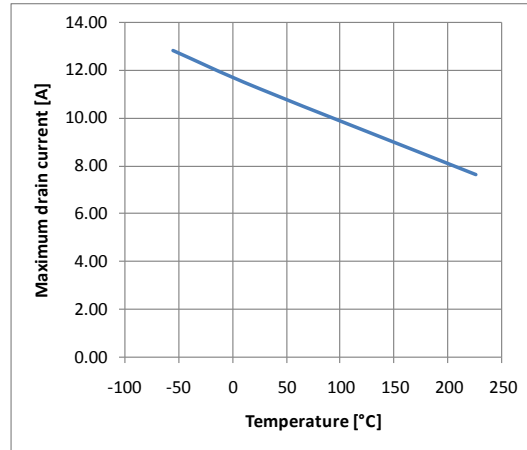
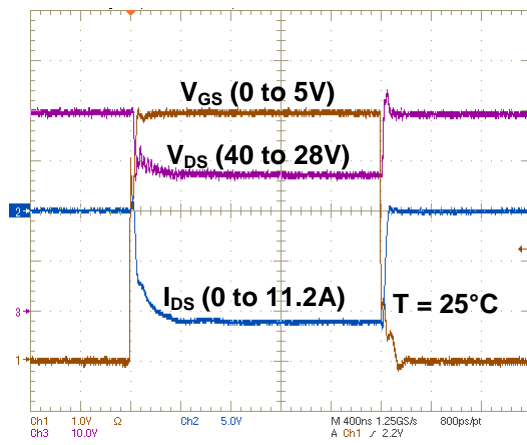
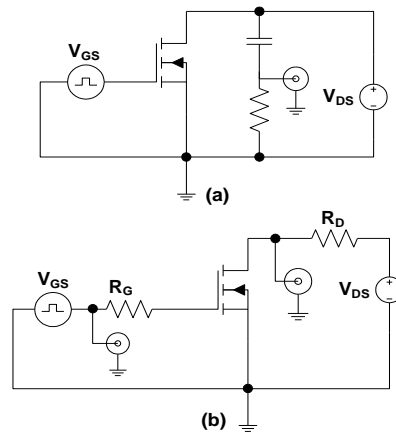
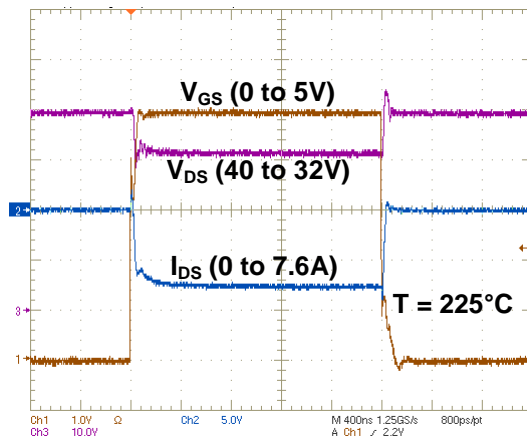
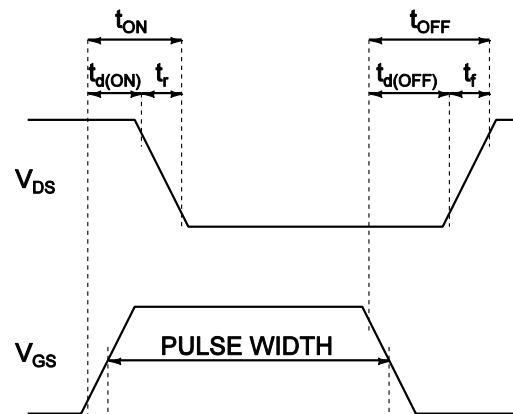
**Maximum drain current pulse test (T=-55°C).**

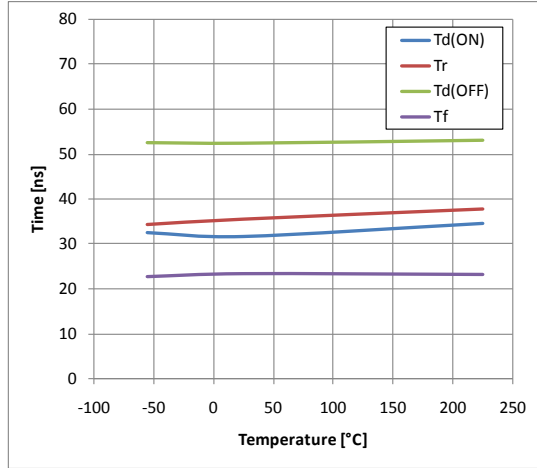
**Peak drain current vs. temperature (V<sub>G</sub>=5V, V<sub>D</sub>=40V).**

**Maximum drain current pulse test (T=25°C).**

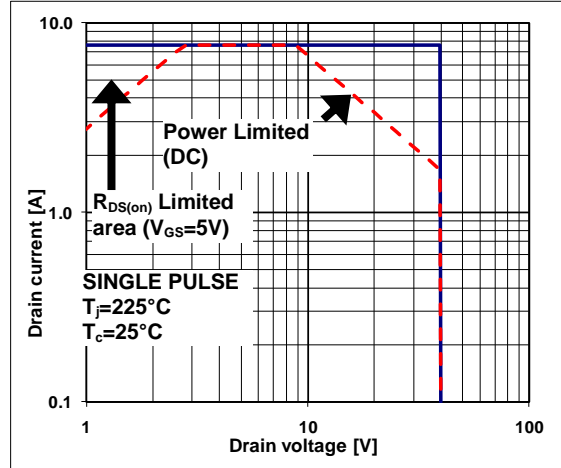
**(a) I<sub>D</sub><sup>MAX</sup> measurement scheme R=1Ω, C=100μF, Compliance (V<sub>DS</sub>=40V)=20mA (b) Timing measurement scheme R<sub>G</sub>=2.7Ω, R<sub>D</sub>=8.2Ω, V<sub>DS</sub>=20V.**

**Maximum drain current pulse test (T=225°C).**

**Timing definition diagram.**



Timing parameters versus temperature.



Forward bias safe operating area.



### Package Dimensions

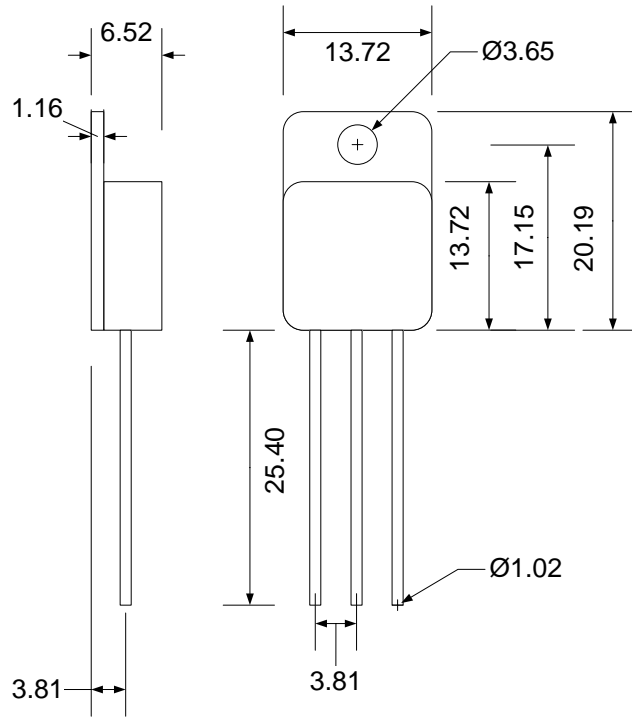

TO254 (mm +/- 10%)

### Ordering Information

Ordering Reference	Package	Temperature Range	Marking
CHT-NMOS4005-TO254-T	TO-254 metal can	-55°C to +225°C	CHT-NMOS4005
CHT-NMOS4010-TO254-T	TO-254 metal can	-55°C to +225°C	CHT-NMOS4010
CHT-NMOS4020-TO254-T	TO-254 metal can	-55°C to +225°C	CHT-NMOS4020



---

## Contact & Ordering

CISSOID S.A.

<b>Headquarters and contact EMEA:</b>	CISSOID S.A. – Rue Francqui, 3 – 1435 Mont Saint Guibert - Belgium T : +32 10 48 92 10 – F : +32 10 88 98 75 Email : <a href="mailto:sales@cissoid.com">sales@cissoid.com</a>
<b>Sales Representatives:</b>	Visit our website: <a href="http://www.cissoid.com">http://www.cissoid.com</a>

## Disclaimer

*Neither CISSOID, nor any of its directors, employees or affiliates make any representations or extend any warranties of any kind, either express or implied, including but not limited to warranties of merchantability, fitness for a particular purpose, and the absence of latent or other defects, whether or not discoverable. In no event shall CISSOID, its directors, employees and affiliates be liable for direct, indirect, special, incidental or consequential damages of any kind arising out of the use of its circuits and their documentation, even if they have been advised of the possibility of such a damage. The circuits are provided "as is". CISSOID has no obligation to provide maintenance, support, updates, or modifications*