

CMT-OPA DATASHEET

Revision: 01.6
22-Feb-22
(Last Modification Date)

High-Temperature General-Purpose Quad Operational Amplifier

General Description

The CMT-OPA is a general-purpose quad operational amplifier for applications over the temperature range from -55 to +175°C. This circuit is fabricated using a CMOS SOI process, assuring latchup-free operation for all operation conditions.

The CMT-OPA can operate with both single and symmetrical power supplies. The supply voltages range goes from 4.5 to 20V.

The CMT-OPA uses internal metal lines presenting extremely high immunity to electromigration, improving product lifetime.

Features

- Qualified from -55 to +175°C (Tj)
- 4.5 to 20V supply voltages
- Single or symmetrical supply operation
- Latchup-free at any supply and temperature condition
- Available in plastic SOIC16 0.300" standard package
- Validated at 175°C for 30000 hours (and still on-going)
- Improved internal metallization for extended reliability

Applications

- Well logging, Automotive, Aeronautics & Aerospace
- Harsh Environments

Package Configurations¹

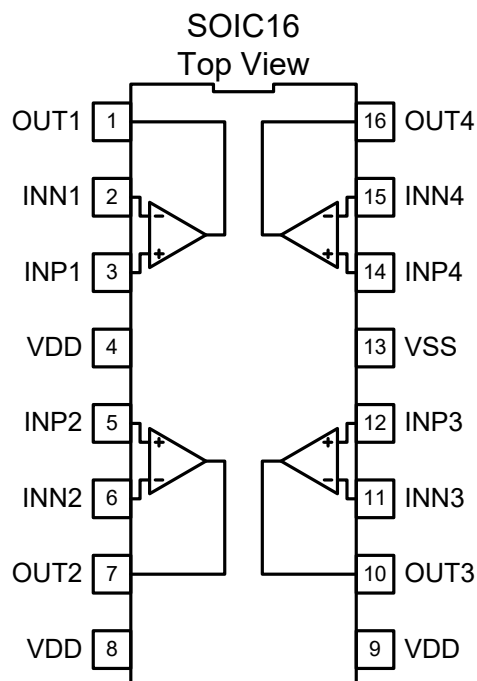

Pin #	Pin Name	Pin Description
1	OUT1	OPA1 output
2	INN1	OPA1 negative input
3	INP1	OPA1 positive input
4	VDD	Positive power supply
5	INP2	OPA2 positive input
6	INN2	OPA2 negative input
7	OUT2	OPA2 output
8	VDD	Positive power supply
9	VDD	Positive power supply
10	OUT3	OPA3 output
11	INN3	OPA3 negative input
12	INP3	OPA3 positive input
13	VSS	Negative power supply
14	INP4	OPA4 positive input
15	INN4	OPA4 negative input
16	OUT4	OPA4 output

¹ Other packages available upon request.

Absolute Maximum Ratings

 Supply Voltage VDD to VSS -0.5 to 25V
 Voltage on any Pin to VSS -0.5 to V_{DD}+0.5V

Operating Conditions

 Supply Voltage VDD to VSS 4.5V to 20V
 Junction temperature -55°C to +175°C

ESD Rating (expected)

Human Body Model <1kV

DC Electrical Characteristics

 Unless otherwise stated: VDD=10V, VSS=0V, T_j=25°C. **Bold underlined** values indicate values over the whole temperature range (-55°C < T_j < +175°C).

Parameter	Condition	Min	Typ	Max	Units
Supply voltage VDD-VSS		4.5		20	V
Supply current (full package) I_{DD}	T _j =25°C			1.7	mA
	T _j =-55 to +175°C			<u>2.0</u>	
Output voltage swing V_o	RL=2kΩ, THD ¹ =1%	0.15		VDD-0.18	V
	RL=∞, THD=0.1%	0.03		VDD-0.02	
Output current ^{2,3} I_o	T _j =-55 to +175°C			<u>±15</u>	mA
Common mode input range V_{CM}	T _j =+175°C	1.5		VDD-0.1	V
	T _j =-55°C	2.0		VDD-0.2	
Input offset voltage ⁴ V_{IOFF}	T _j =25°C		<±2.5	±11	mV
	T _j =+175°C		<±2.5	±8	
Input offset drift ³ TC_{VIOFF}	T _j =25°C		<±5	±15	μV/°C
Input bias current ⁵ I_B	T _j =-55 to +175°C			<u>±10</u>	nA
Input offset current ⁴ I_{OFF}	T _j =25°C			±0.01	nA
	T _j =+175°C			±10	

¹ Total Harmonic Distortion.

² Source or sink.

³ Output current is not internally limited. Value given indicate the maximum recommended conditions.

⁴ The absolute value of the input offset voltage, |V_{IOFF}|, decreases as temperature increases. TC_{VIOFF} must be used so that |V_{IOFF}| decreases with temperature, i.e. TC_{VIOFF} has opposite sign than V_{IOFF}.

⁵ Due to ESD structures. Under full characterization.

AC Electrical Characteristics

 Unless otherwise stated: VDD=10V, VSS=0V, T_J=25°C. **Bold underlined** values indicate values over the whole temperature range (-55°C < T_J < +175°C).

Parameter	Condition	Min	Typ	Max	Units
DC gain A_o	RL=2kΩ, T _J =25°C	90	100		dB
	RL=2kΩ, T _J =+175°C	85	95		
Gain-bandwidth product GBW	RL=∞, CL=30pF		<u>1.5</u>		MHz
	RL=2kΩ, CL=30pF	<u>0.95</u>	<u>1.3</u>		
Common mode rejection ratio CMRR	DC to 1kHz	<u>86</u>			dB
Power supply rejection ratio PSRR	Positive or negative. DC to 100Hz	<u>78</u>			dB
Slew rate SR	RL=2kΩ, CL=30pF T _J =25°C	1.0	1.2		V/μsec
	RL=2kΩ, CL=30pF T _J =+175°C	1.4	1.6		
Phase margin Φ _M	RL=2kΩ, CL=30pF	<u>50</u>	<u>>60</u>		Degree
Input noise spectral density	F=1Hz		11.0		μV/√Hz
	F=100Hz		1.2		
	F=1kHz		0.43		
	F=10kHz		0.19		
Integrated input noise e_n	DC to 10Hz, T _J =-55 to +175°C		25		μV _{RMS}

Typical Performance Characteristics

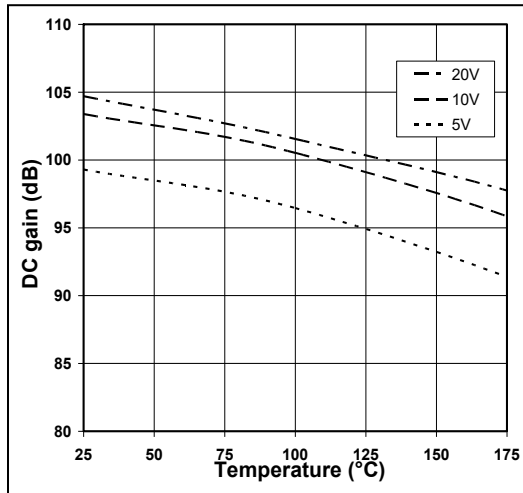

DC Gain vs. Temperature for $V_{DD} = 5/10/20V$

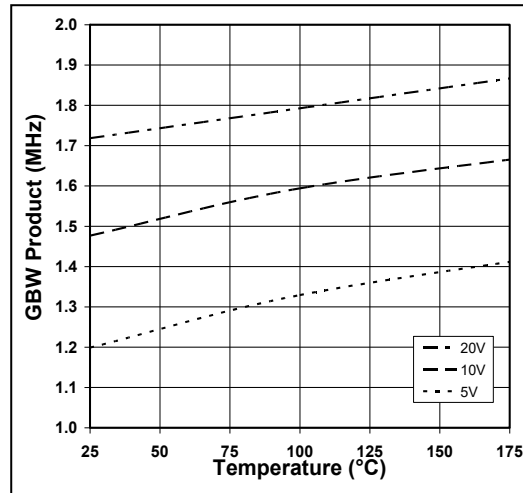

GBW vs. Temperature for $V_{DD} = 5/10/20V$

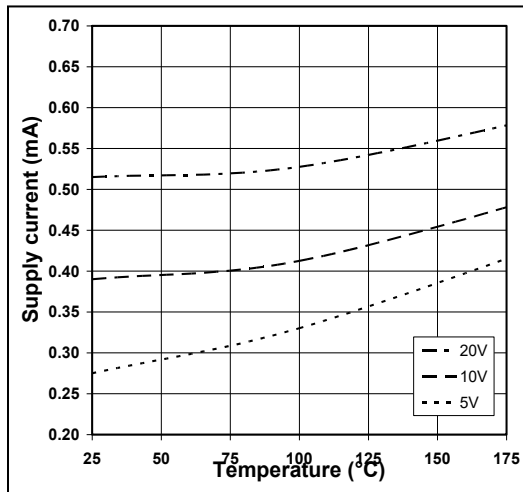

Current consumption per amplifier vs. Temperature for $V_{DD} = 5/10/20V$

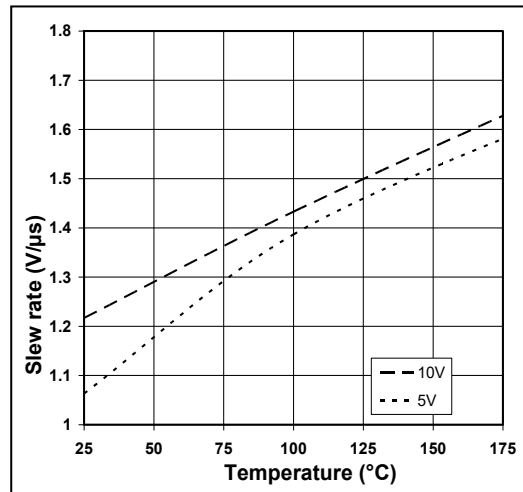

Slew Rate vs. Temperature for $V_{DD} = 5/10V$

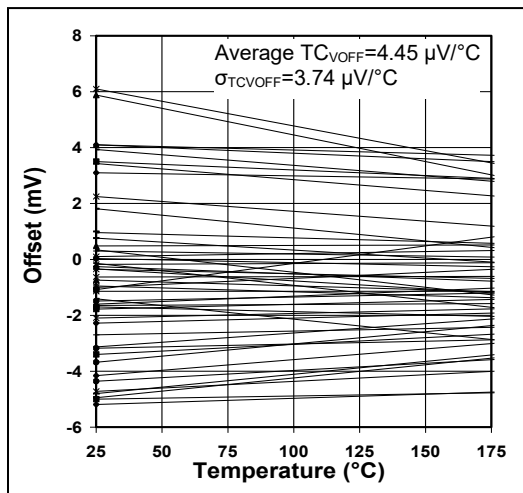

Offset voltage vs. Temperature

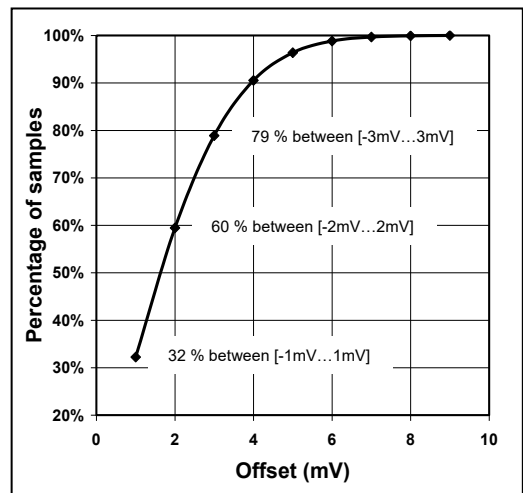

Sample size vs. Offset voltage

Circuit Functionality

Operating conditions

The CHT-OPA has been qualified to operate with supply voltages ranging from 4.5V to 20V and temperatures from -55°C to 225°C. Device characteristics vary smoothly outside the qualification temperature range.

With supply voltage above 5.5V, the CHT-OPA must be used in closed loop configuration under linear regime. If the application fails to be compliant to this requirement, this will lead to violation of the "Safe Operating Area" conditions inside the CHT-OPA device.

For supply voltages below 5.5V, no limitation on the operation regime exists and the part can even be used as comparator. When CHT-OPA is used in non-linear regime (eg used as comparator), if the voltage difference between the 2 input pins exceeds 2V typ., current will flow between the 2 input pins according to following formula:

$$I = \frac{V(INP) - V(INN) - 2V}{20K\Omega}$$

Specific Operating Conditions

The CMT-OPA presents slightly different positive and negative slewing values. This makes that when a square wave is used as input signal, the output presents an additional DC offset due to the slight change of the output duty cycle.

Additionally, for square input signals with frequencies above 10kHz, the circuit presents an output DC offset which increases with the input frequency. At 30kHz, the input referred offset increases by about 20mV.

Ordering Information

Ordering Reference	Package	Temperature Range	Marking
CMT-OPA-PSOIC16-T	0.300" Plastic SOIC16	-55°C to +175°C	CMT-OPA

Package Dimensions

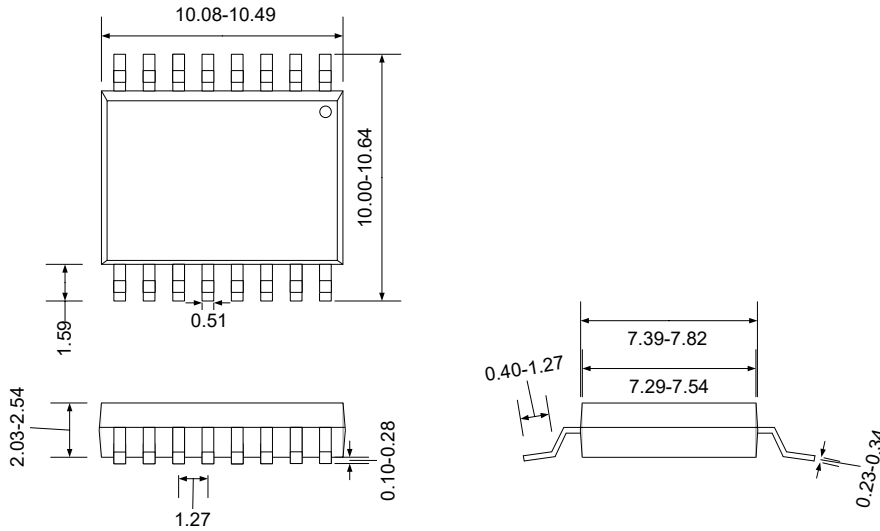

Drawing PSOIC16 (mm)

Contact & Ordering

CISSOID S.A.

Headquarters and contact EMEA:	CISSOID S.A. – Rue Francqui, 3 – 1435 Mont Saint Guibert - Belgium T : +32 10 48 92 10 – F : +32 10 88 98 75 Email : sales@cissoid.com
Sales Representatives:	Visit our website: http://www.cissoid.com

Disclaimer

Neither CISSOID, nor any of its directors, employees or affiliates make any representations or extend any warranties of any kind, either express or implied, including but not limited to warranties of merchantability, fitness for a particular purpose, and the absence of latent or other defects, whether or not discoverable. In no event shall CISSOID, its directors, employees and affiliates be liable for direct, indirect, special, incidental or consequential damages of any kind arising out of the use of its circuits and their documentation, even if they have been advised of the possibility of such a damage. The circuits are provided "as is". CISSOID has no obligation to provide maintenance, support, updates, or modifications.