

---

# CHT-OPA DATASHEET

*Revision: 2.7*  
*Dec. 10, 2023*  
(Last Modification Date)

## High-Temperature General-Purpose Quad Operational Amplifier

---

### General Description

The CHT-OPA is a general-purpose quad operational amplifier for applications over the temperature range from -55 to 225°C.

The CHT-OPA can operate with both single and symmetrical power supplies. The supply voltages range goes from 4.5 to 20V.

The CHT-OPA uses internal metal lines presenting extremely high immunity to electromigration, improving product lifetime.

### Features

- Qualified from -55 to +225°C (Tj)
- 4.5 to 20V supply voltages
- Single or symmetrical supply operation
- Latchup-free at any supply and temperature condition
- Validated at 225°C for 30000 hours (and still on-going)
- Available in DIL14 and SOIC16 hermetic ceramic standard packages

### Applications

- Well logging, Automotive, Aeronautics & Aerospace
  - Harsh Environments
-

## Package Configurations<sup>1</sup>

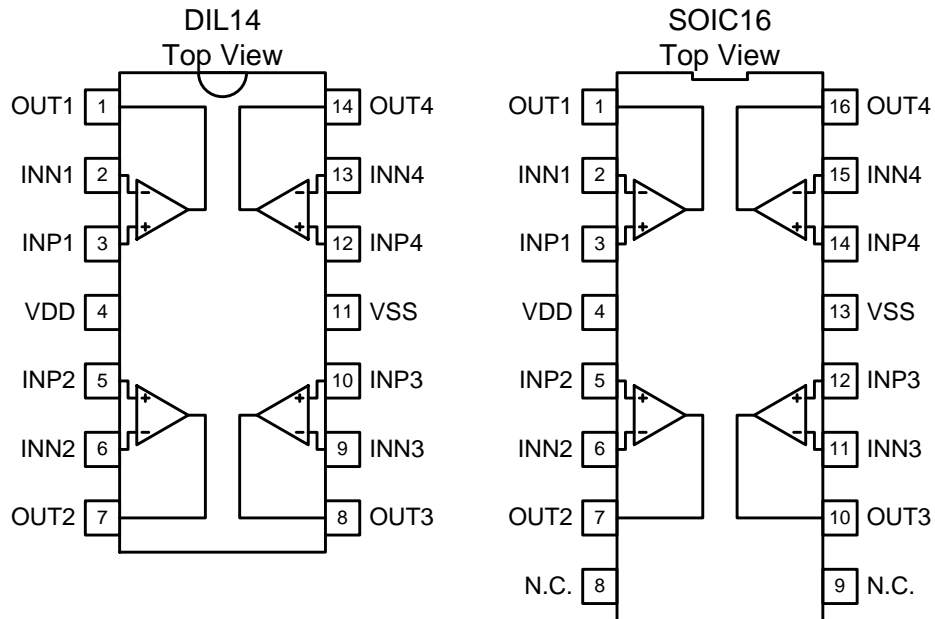

Pin #	Pin Name	Pin Description
1	OUT1	OPA1 output
2	INN1	OPA1 negative input
3	INP1	OPA1 positive input
4	VDD	Positive power supply
5	INP2	OPA2 positive input
6	INN2	OPA2 negative input
7	OUT2	OPA2 output
8	OUT3	OPA3 output
9	INN3	OPA3 negative input
10	INP3	OPA3 positive input
11	VSS	Negative power supply
12	INP4	OPA4 positive input
13	INN4	OPA4 negative input
14	OUT4	OPA4 output

Pin #	Pin Name	Pin Description
1	OUT1	OPA1 output
2	INN1	OPA1 negative input
3	INP1	OPA1 positive input
4	VDD	Positive power supply
5	INP2	OPA2 positive input
6	INN2	OPA2 negative input
7	OUT2	OPA2 output
8	N.C.	Not connected pin
9	N.C.	Not connected pin
10	OUT3	OPA3 output
11	INN3	OPA3 negative input
12	INP3	OPA3 positive input
13	VSS	Negative power supply
14	INP4	OPA4 positive input
15	INN4	OPA4 negative input
16	OUT4	OPA4 output

<sup>1</sup> Other packages available upon request.

### Absolute Maximum Ratings

Supply Voltage VDD to VSS -0.5 to 25V  
Voltage on any Pin to VSS -0.5 to V<sub>DD</sub>+0.5V

### Operating Conditions

Supply Voltage VDD to VSS 4.5V to 20V  
Junction temperature -55°C to +225°C

### ESD Rating (expected)

Human Body Model 1kV

## DC Electrical Characteristics

Unless otherwise stated: VDD=10V, VSS=0V, T<sub>j</sub>=25°C. **Bold underlined** values indicate values over the whole temperature range (-55°C < T<sub>j</sub> < +225°C).

Parameter	Condition	Min	Typ	Max	Units
Supply voltage <b>VDD-VSS</b>		4.5		20	V
Supply current (full package) <b>I<sub>DD</sub></b>	T <sub>j</sub> =25°C			1.7	mA
	T <sub>j</sub> =-55 to 225°C			<b><u>2.2</u></b>	
Output voltage swing <b>V<sub>o</sub></b>	R <sub>L</sub> =2kΩ, THD <sup>1</sup> =1%	0.15		VDD-0.18	V
	R <sub>L</sub> =∞, THD=0.1%	0.03		VDD-0.02	
Output current <sup>2,3</sup> <b>I<sub>o</sub></b>	T <sub>j</sub> =-55 to 225°C			<b><u>±15</u></b>	mA
Common mode input range <b>V<sub>CM</sub></b>	T <sub>j</sub> =225°C	1.5		VDD-0.1	V
	T <sub>j</sub> =-55°C	2.0		VDD-0.2	
Input offset voltage <sup>4</sup> <b>V<sub>IOFF</sub></b>	T <sub>j</sub> =25°C		<±2.5	±8	mV
Input offset drift <sup>3</sup> <b>TC<sub>VIOFF</sub></b>	T <sub>j</sub> =25°C		<±5	±15	μV/°C
Input bias current <sup>5</sup> <b>I<sub>B</sub></b>	T <sub>j</sub> =-55 to 225°C			<b><u>±10</u></b>	nA
Input offset current <sup>4</sup> <b>I<sub>OFF</sub></b>	T <sub>j</sub> =25°C			±0.01	nA
	T <sub>j</sub> =225°C			±10	

<sup>1</sup> Total Harmonic Distortion.

<sup>2</sup> Source or sink.

<sup>3</sup> Output current is not internally limited. Value given indicate the maximum recommended conditions.

<sup>4</sup> The absolute value of the input offset voltage, |V<sub>IOFF</sub>|, decreases as temperature increases. TC<sub>VIOFF</sub> must be used so that |V<sub>IOFF</sub>| decreases with temperature, i.e. TC<sub>VIOFF</sub> has opposite sign than V<sub>IOFF</sub>.

<sup>5</sup> Due to ESD structures. Under full characterization.

### AC Electrical Characteristics

Unless otherwise stated: VDD=10V, VSS=0V, T<sub>j</sub>=25°C. **Bold underlined** values indicate values over the whole temperature range (-55°C < T<sub>j</sub> < +225°C).

Parameter	Condition	Min	Typ	Max	Units
DC gain A <sub>o</sub>	RL=2kΩ, T <sub>j</sub> =25°C	90	100		dB
	RL=2kΩ, T <sub>j</sub> =225°C	80	87		
Gain-bandwidth product <b>GBW</b>	RL=2kΩ, CL=30pF	<b><u>1.3</u></b>	<b><u>1.5</u></b>		MHz
Common mode rejection ratio <b>CMRR</b>	DC to 1kHz	<b><u>86</u></b>			dB
Power supply rejection ratio <b>PSRR</b>	Positive or negative. DC to 100Hz	<b><u>78</u></b>			dB
Slew rate <b>SR</b>	RL=2kΩ, CL=30pF T <sub>j</sub> =25°C	1.0	1.2		V/μsec
	RL=2kΩ, CL=30pF T <sub>j</sub> =225°C	1.6	1.7		
Phase margin Φ <sub>M</sub>	RL=2kΩ, CL=30pF	<b><u>50</u></b>	<b><u>&gt;60</u></b>		Degree
Input noise spectral density	F=1Hz		11.0		μV/√Hz
	F=100Hz		1.2		
	F=1kHz		0.43		
	F=10kHz		0.19		
Integrated input noise <b>e<sub>n</sub></b>	DC to 10Hz, T <sub>j</sub> =-55 to 225°C		25		μV <sub>RMS</sub>

### Typical Performance Characteristics

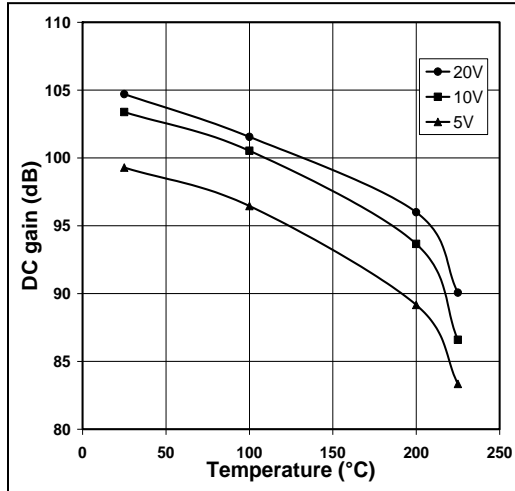

DC Gain vs. Temperature for  $V_{DD} = 5/10/20V$

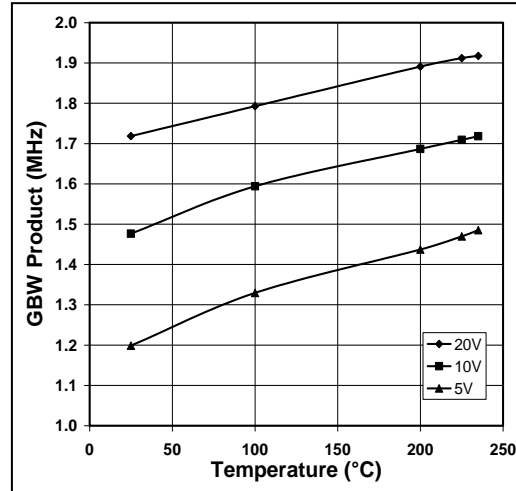

GBW vs. Temperature for  $V_{DD} = 5/10/20V$

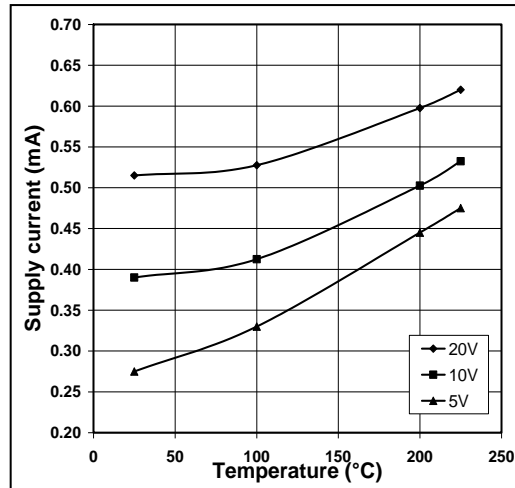

Current consumption per amplifier vs. Temperature for  $V_{DD} = 5/10/20V$

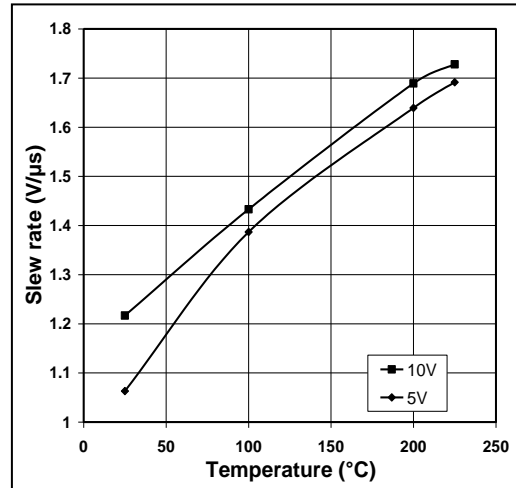

Slew Rate vs. Temperature for  $V_{DD} = 5/10V$

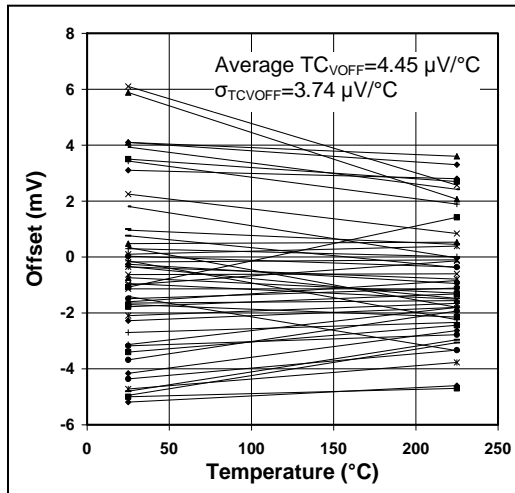

Offset voltage vs. Temperature

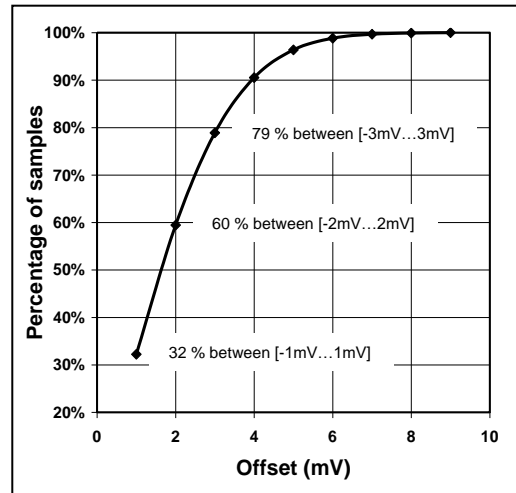

Sample size vs. Offset voltage

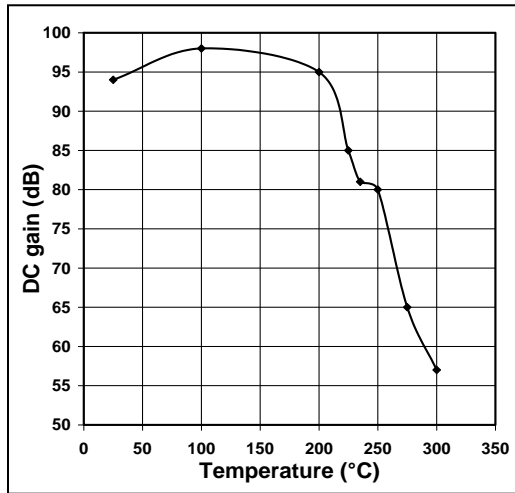

DC Gain vs. Temperature for  $V_{DD} = 10V$ .  
Typical

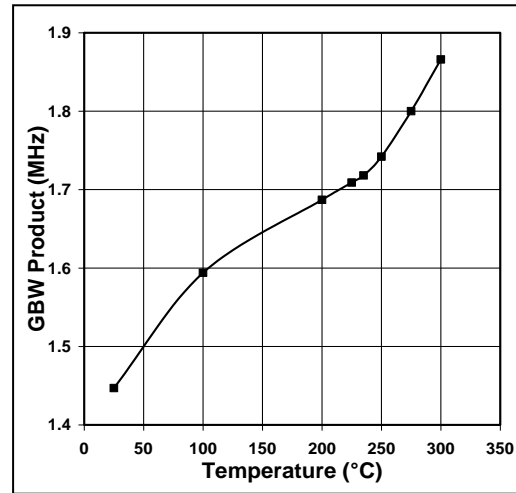

GBW vs. Temperature for  $V_{DD} = 10V$ .  
Typical

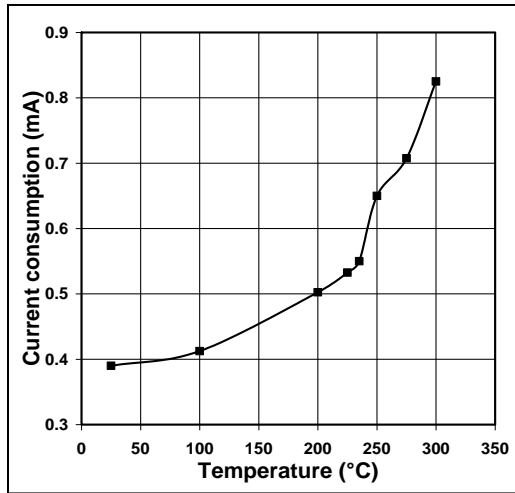

Current consumption per aplifier vs. Temperature for  $V_{DD} = 10V$ . Typical

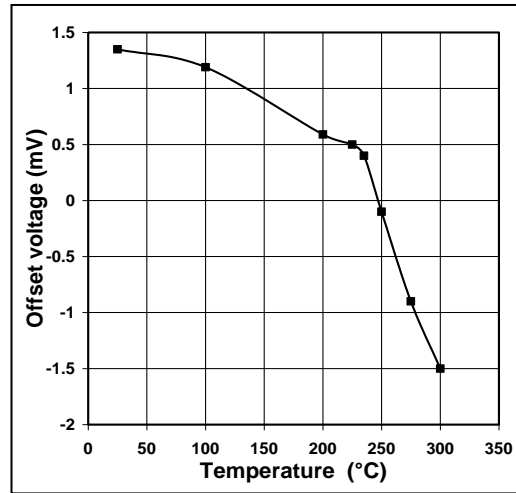

Offset voltage vs. Temperature.  
Typical

## Circuit Functionality

### Operating conditions

The CHT-OPA has been qualified to operate with supply voltages ranging from 4.5V to 20V and temperatures from -55°C to 225°C. Device characteristics vary smoothly outside the qualification temperature range.

With supply voltage above 5.5V, the CHT-OPA must be used in closed loop configuration under linear regime. If the application fails to be compliant to this requirement, this will lead to violation of the "Safe Operating Area" conditions inside the CHT-OPA device.

For supply voltages below 5.5V, no limitation on the operation regime exists and the part can even be used as comparator. When CHT-OPA is used in non-linear regime (eg used as comparator), if the voltage difference between the 2 input pins exceeds 2V typ., current will flow between

the 2 input pins according to following formula:

$$I = \frac{V(INP) - V(INN) - 2V}{20K\Omega}$$

### Specific Operating Conditions

The CHT-OPA presents slightly different positive and negative slewing values. This makes that when a square wave is used as input signal, the output presents an additional DC offset due to the slight change of the output duty cycle.

Additionally, for square input signals with frequencies above 10kHz, the circuit presents an output DC offset which increases with the input frequency. At 30kHz, the input referred offset increases by about 20mV.





## Contact & Ordering

CISSOID S.A.

<b>Headquarters and contact EMEA:</b>	CISSOID S.A. – Rue Francqui, 11 – 1435 Mont Saint Guibert - Belgium T : +32 10 48 92 10 - F: +32 10 88 98 75 Email: <a href="mailto:sales@cissoid.com">sales@cissoid.com</a>
<b>Representatives</b>	Visit our website: <a href="http://www.cissoid.com">www.cissoid.com</a>

## Disclaimer

*Neither CISSOID, nor any of its directors, employees or affiliates make any representations or extend any warranties of any kind, either express or implied, including but not limited to warranties of merchantability, fitness for a particular purpose, and the absence of latent or other defects, whether or not discoverable. In no event shall CISSOID, its directors, employees and affiliates be liable for direct, indirect, special, incidental or consequential damages of any kind arising out of the use of its circuits and their documentation, even if they have been advised of the possibility of such a damage. The circuits are provided "as is". CISSOID has no obligation to provide maintenance, support, updates, or modifications.*