

CHT-ADC10 Datasheet

Version: 1.8
20-Dec-23
(Last Modification Date)

High-Temperature Ultra-low-power 10-bit ADC

General Description

The CHT-ADC10 is a high-temperature, ultra-low-power, highly stable analog-to-digital converter. This successive approximation ADC is based on an R-2R network and features 10 bits of resolution and a strictly monotonic characteristic from -55°C up to +225°C. An optional internal clock generator is included to provide stand-alone operation. It includes Sample&Hold and μ P interface with possibility of serial data transfer. Both parallel and serial interfaces can be used simultaneously. A special control line allows for doubling the frequency of the internal clock generator for reduced throughput time. The maximum sampling rate is 25kS/s. Several input ranges are available from -15V up to +10V. It only requires a +5V supply and an external +5V reference.

The CHT-ADC10 is latch-up free and the fabrication technology guarantees a high reliability at extreme temperatures.

Features

- 10 bit-resolution with optional internal clock, Sample/Hold, μ C interface with parallel or serial data transfer
- Up to 25kS/s
- +5V power supply only
- Low total supply current (<250 μ A)
- Operational from -55 to +225°C with very low drift
- Validated at 225°C for 20000 hours (and still on-going)
- Available in die, CDIL28 and CSOIC28

Applications

- Oil&Gas, Industrial, Automotive, Aeronautics & Aerospace
- Electric Power Conversion

Package Configurations¹

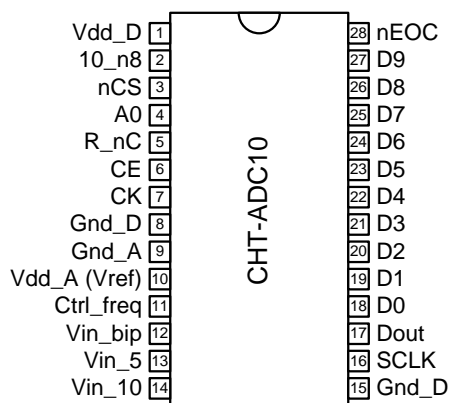

¹ Pinout is identical for CDIL28 and CSOIC28. Other packages available upon request.

Ordering Information

Ordering Reference	Package	Temperature Range	Marking	Status
CHT-ADC10-CDIL28-T	Ceramic DIL28	-55°C to +225°C	CHT-ADC10	Not for new design
CHT-ADC10-CSOIC28-T	Ceramic SOIC28	-55°C to +225°C	CHT-ADC10	

Functional Block Diagram

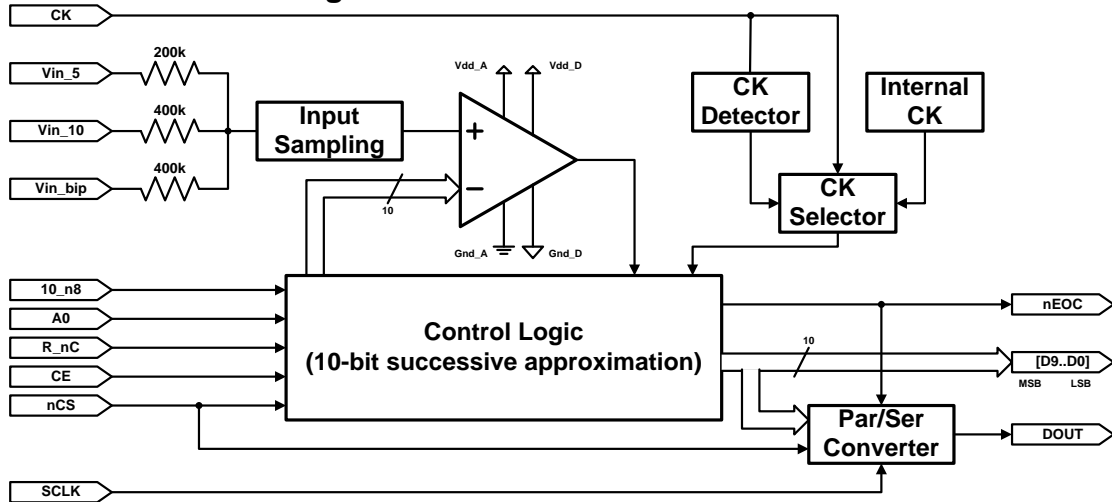

Pin Description

Pin#	Symbol	Type ¹	Function
1	Vdd_D	SD	+5V digital supply (+/- 5%).
2	10_n8	DI	Determines whether output data is to be organized as two 8-bit words (low) or a single 10-bit word (high).
3	nCS	DI	(active low) Chip Select.
4	A0	DI	During the read cycle, if 10_n8 is low, A0 low enables the 8 MSBs (D9...D2) while A0 high enables (D1,D0) and sets (D7...D2)=0.
5	R_nC	DI	Read/Convert. Active high for Read and low for write.
6	CE	DI	(active high) Chip Enable.
7	CK	DI	Optional clock input. <u>Must be grounded if not used.</u> If used, should preferably be high during 12µs after the starting of conversion for noise reasons. Range: 10kHz and 500kHz ; duty-cycle:10% to 90%.
8	Gnd_D	SD	Digital ground.
9	Gnd_A	SA	Analog ground.
10	Vdd_A (Vref)	SA	Analog supply voltage. It is also used as internal voltage reference. Must be a <u>precise and noiseless</u> 5V supply (current <200µA). The accuracy of this reference directly affects the ADC gain error.
11	Ctrl_freq	DI	Should be high for normal operation. If low, it doubles the internal oscillator frequency (~500kHz) at cost of a lower precision.
12	Vin_bip	AI	Analog signal input. It is connected to an internal 400kΩ resistor. See Static Characteristics table for possible input ranges.

Pin#	Symbol	Type ¹	Function
13	Vin_5	AI	Analog signal input. It is connected to an internal 200kΩ resistor. See Static Characteristics table for possible input ranges.
14	Vin_10	AI	Analog signal input. It is connected to an internal 400kΩ resistor. See Static Characteristics table for possible input ranges.
15	Gnd_D	SD	Digital ground.
16	SCLK	DI	Must be low whilst CS is active with a conversion in progress. After End-of-Conversion, each SCLK falling edge shifts data out through DOUT. Maximum SCLK frequency is 10MHz.
17	Dout	DO	Tri-state serial data output. When nCS is high, Dout is in high-impedance state. When nCS is low, Dout is low during conversion and goes high at end of conversion. After this rising edge, new data (starting from MSB) go out at each falling edge of SCLK.
18	D0 (LSB)	DO	Tri-state parallel data output.
19	D1	DO	
20	D2	DO	
21	D3	DO	
22	D4	DO	
23	D5	DO	
24	D6	DO	
25	D7	DO	
26	D8	DO	
27	D9(MSB)	DO	
28	nEOC	DO	Represents the End-of-Conversion (active low) flag.

¹ Type: S=Supply, A=Analog; D=Digital; I=input; O=output

Absolute Maximum Ratings

Supply Voltage V_{DD} to GND -0.5 to 5.5V
Voltage on any Pin to GND -0.5 to $V_{DD}+0.5V$

Operating Conditions

Supply Voltage V_{DD} to GND $5V \pm 5\%$
Junction temperature $-55^{\circ}C$ to $+225^{\circ}C$

ESD Rating (expected)

Human Body Model (expected) <1kV

Stresses above those listed in "Absolute Maximum Ratings" may cause permanent damage to the device. This is a stress only rating and operation of the device at these or any other conditions above those indicated in the operational sections of this specification is not implied. Frequent or extended exposure to absolute maximum rating conditions or above may affect device reliability.

Electrical Characteristics

Unless otherwise stated: $V_{DD} = 5V \pm 5\%$, $T_j = 25^\circ C$, output data rate = 10 kS/s. **Bold** figures indicate values over the whole temperature range ($-55^\circ C < T_j < 225^\circ C$).

Parameter	Condition	Min	Typ	Max	Units
Digital Supply voltage (V_{DD})		4.75	5.00	5.25	V
Analog Supply voltage (V_{DDA})	Used as internal voltage reference		5		V
Current consumption (analog part)	-55°C 225°C		134 164		μA
Current consumption (digital part)	Using external CK		55		μA
	Using internal CK		70		μA

Static characteristics

Unless otherwise stated: $V_{DD} = 5V \pm 5\%$, $T_j = 25^\circ C$. **Bold** figures indicate values over the whole temperature range ($-55^\circ C < T_j < 225^\circ C$). Units are referred to 10 bit word. Selected input range = 0 to 5V.

Parameter	Condition	Min	Typ	Max	Units																																																					
Resolution		10			Bits																																																					
DNL ¹			1.3	1.5	LSB																																																					
INL ²			1.3	1.5	LSB																																																					
Missing code			0	1																																																						
Monotonicity			OK																																																							
Offset ²			17		LSB ²																																																					
Gain Error ³			1.5		%																																																					
Temperature Drift (d/dT°) - Offset - Gain Error			-0.023 -19		LSB/°C ppm/°C																																																					
Selectable Analog Input Ranges	<table border="1"> <thead> <tr> <th>Vin 5</th> <th>Vin 10</th> <th>Vin bip</th> </tr> </thead> <tbody> <tr><td>gndA</td><td>in</td><td>gndA</td></tr> <tr><td>in</td><td>gndA</td><td>gndA</td></tr> <tr><td>in</td><td>in</td><td>gndA</td></tr> <tr><td>in</td><td>in</td><td>in</td></tr> <tr><td>in</td><td>in</td><td>vddA</td></tr> <tr><td>in</td><td>gndA</td><td>vddA</td></tr> <tr><td>gndA</td><td>in</td><td>vddA</td></tr> <tr><td>in</td><td>vddA</td><td>vddA</td></tr> <tr><td>vddA</td><td>in</td><td>gndA</td></tr> <tr><td>vddA</td><td>in</td><td>vddA</td></tr> </tbody> </table>	Vin 5	Vin 10	Vin bip	gndA	in	gndA	in	gndA	gndA	in	in	gndA	in	in	in	in	in	vddA	in	gndA	vddA	gndA	in	vddA	in	vddA	vddA	vddA	in	gndA	vddA	in	vddA	<table border="1"> <tbody> <tr><td>0</td></tr> <tr><td>0</td></tr> <tr><td>0</td></tr> <tr><td>0</td></tr> <tr><td>-1.67</td></tr> <tr><td>-2.5</td></tr> <tr><td>-5</td></tr> <tr><td>-5</td></tr> <tr><td>-10</td></tr> <tr><td>-15</td></tr> </tbody> </table>	0	0	0	0	-1.67	-2.5	-5	-5	-10	-15		<table border="1"> <tbody> <tr><td>10</td></tr> <tr><td>5</td></tr> <tr><td>3.33</td></tr> <tr><td>2.5</td></tr> <tr><td>1.67</td></tr> <tr><td>2.5</td></tr> <tr><td>5</td></tr> <tr><td>0</td></tr> <tr><td>0</td></tr> <tr><td>-5</td></tr> </tbody> </table>	10	5	3.33	2.5	1.67	2.5	5	0	0	-5	V
	Vin 5	Vin 10	Vin bip																																																							
	gndA	in	gndA																																																							
	in	gndA	gndA																																																							
	in	in	gndA																																																							
	in	in	in																																																							
	in	in	vddA																																																							
	in	gndA	vddA																																																							
	gndA	in	vddA																																																							
	in	vddA	vddA																																																							
	vddA	in	gndA																																																							
vddA	in	vddA																																																								
0																																																										
0																																																										
0																																																										
0																																																										
-1.67																																																										
-2.5																																																										
-5																																																										
-5																																																										
-10																																																										
-15																																																										
10																																																										
5																																																										
3.33																																																										
2.5																																																										
1.67																																																										
2.5																																																										
5																																																										
0																																																										
0																																																										
-5																																																										
Input Impedance - Sample phase - Hold phase	For [0...5V] range. Can change up to a factor of 2 for other ranges.	144 288	200 400	245 490	kΩ																																																					

¹ Value extracted with code density method, using 200kHz external clock.

² For [0...5]V range, DAC transfer function is: $D = \text{Offset} + (1024/5) \cdot A \cdot (1 - (\text{Gain Error}/100))$

Timing Characteristics

Unless otherwise stated: $V_{DD} = 5V \pm 5\%$, $T_j = 25^\circ C$, output data rate = 10 kS/s. **Bold** figures indicate values over the whole temperature range ($-55^\circ C < T_j < 225^\circ C$).

Parameter	Condition	Min	Typ	Max	Units
External CK frequency	Duty cycle between 10% and 90%	10	250	500	kHz
Output data rate		0.8	16	25	kS/s
Data Output Delay (clock edge to valid data)	TBD				ns
Sampling time before Hold	When conversion starts, actual sampling occurs after this sampling time.	8	10	12	μs
Data latency	Occurs when S/H goes to hold state.		13		cycles
Conversion time (t_c)	Cfr figure 12 for timing diagram		58		μs
NEOC delay from CE (t_{DSC})	Cfr figure 12 for timing diagram		15		ns
CE pulse width (t_{HEC})	Cfr figure 12 for timing diagram	40			ns
nCS to CE high setup time (t_{SSC})	Cfr figure 12 for timing diagram	40			ns
nCS to CE high hold time (t_{HSC})	Cfr figure 12 for timing diagram	40			ns
R_nC to CE high setup time (t_{SRC})	Cfr figure 12 for timing diagram	40			ns
R_nC to CE high hold time (t_{HRC})	Cfr figure 12 for timing diagram	40			ns
A0 to CE high setup time (t_{SAC})	Cfr figure 12 for timing diagram	5			ns
A0 to CE high hold time (t_{HAC})	Cfr figure 12 for timing diagram	40			ns
Access time (t_{DD})	Cfr figure 13 for timing diagram		9		ns
Data valid to CE low hold time (t_{HD})	Cfr figure 13 for timing diagram		6		ns
Output float after CE falling edge (t_{HL})	Cfr figure 13 for timing diagram		11		ns
nCS to CE high setup time (t_{SSR})	Cfr figure 13 for timing diagram	40			ns
R_nC to CE high setup time (t_{SRR})	Cfr figure 13 for timing diagram	40			ns
A0 to CE high setup time (t_{SAR})	Cfr figure 13 for timing diagram	40			ns
nCS to CE low hold time (t_{HSR})	Cfr figure 13 for timing diagram		0		ns
R_nC to CE low hold time (t_{HRR})	Cfr figure 13 for timing diagram		0		ns
A0 to CE low hold time (t_{HAR})	Cfr figure 13 for timing diagram	40			ns
D<9..0> delay from SCLK falling edge	Cfr figure 15 for timing diagram	4	10	25	ns

AC Characteristics

Unless otherwise stated: $V_{DD}=5V\pm 5\%$, $T_j=25^\circ\text{C}$, 13.2kSamples/s, analog input of $4.9V_{pp}$ at 1kHz; $V_{DD}=5V$

Parameter	Condition	Min	Typ	Max	Units
Signal to Noise and distortion ratio (ENOB)	$T_j=25^\circ\text{C}$; external CK 200kHz	9.1	9.47	9.6	dB
	$T_j=225^\circ\text{C}$; external CK 200kHz	-	9.35	-	
	$T_j=25^\circ\text{C}$; internal CK	-	9.30	-	
	$T_j=225^\circ\text{C}$; internal CK	-	9.13	-	
ENOB	$T_j=25^\circ\text{C}$; external CK 200kHz		9.31		dB
	-Vddd=4.75V		9.47		
	-Vddd=5.25V		9.55		

Analog to Digital transfer function can be generalized to all input ranges defining:

D= Digital value

A= Analog input value

A_{min} =lowest value of selected analog input range from

A_{max} =highest value of selected analog input range from

Offset= value of D when $A=A_{min}$. Offset value is independent of range.

GE=Gain-Error (in %). GE value is independent of range.

$$D = \text{Offset} + (A - A_{min}) * (1024 / (A_{max} - A_{min})) * (1 - GE / 100).$$

Equation 1

Typical Performance Characteristics

Typical DNL Characteristics (using external clock at 200kHz)

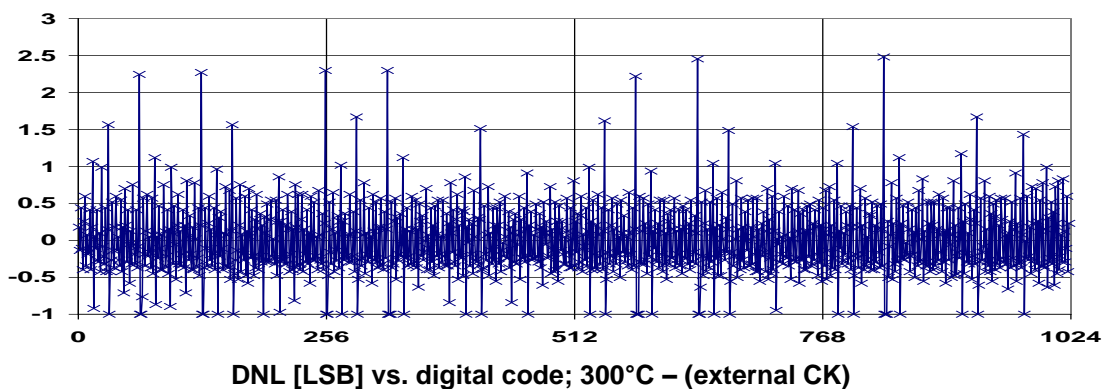
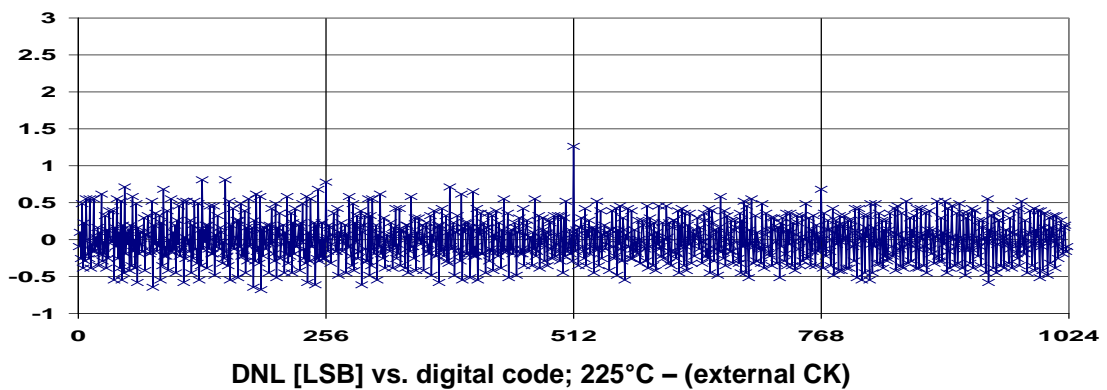
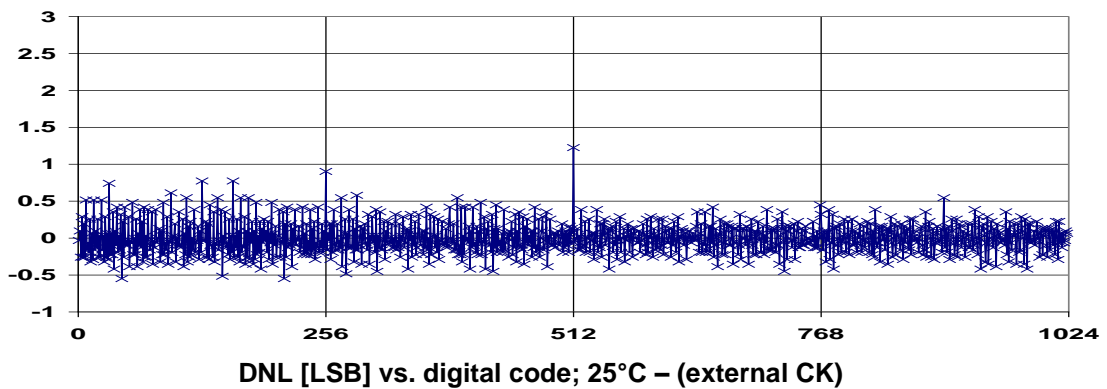
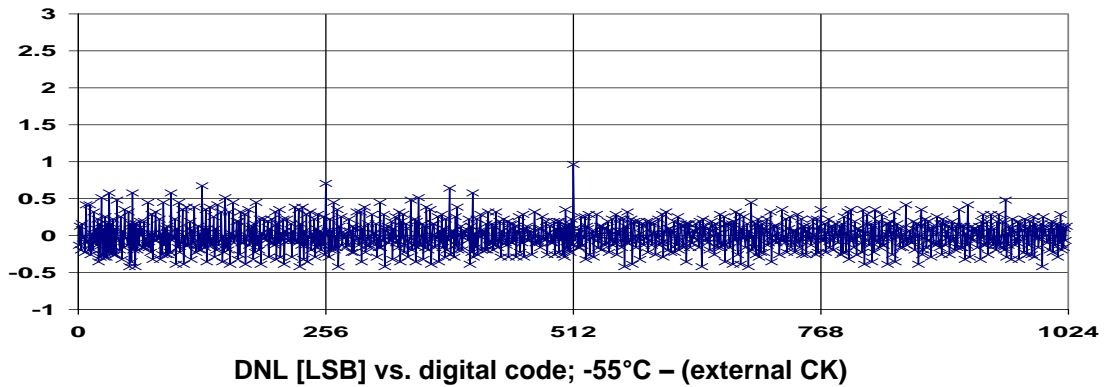
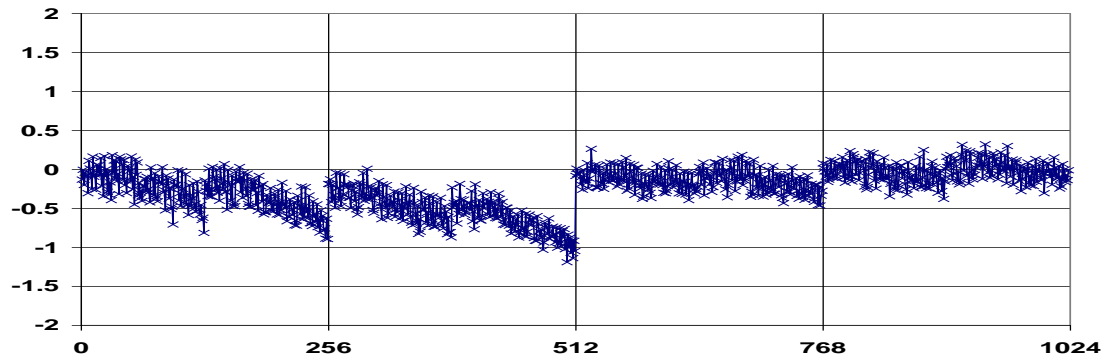
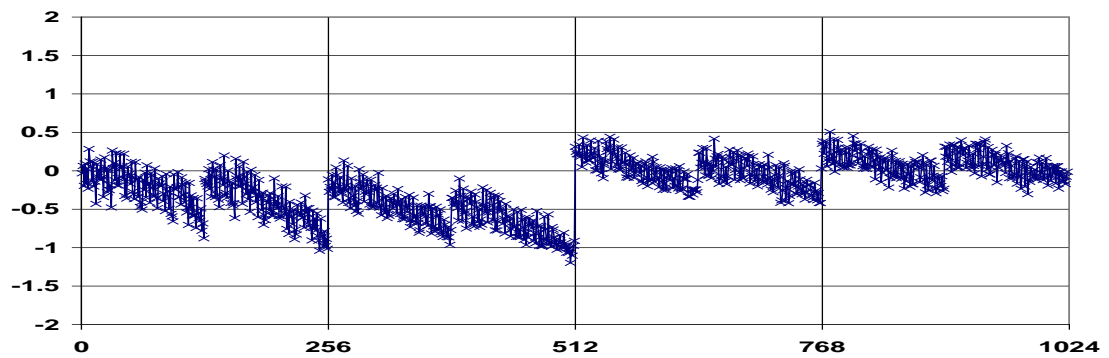

Figure 1

Typical INL Characteristics (using external clock at 200kHz)



INL [LSB] vs. digital code; -55°C – (external CK)



INL [LSB] vs. digital code; 25°C – (external CK)

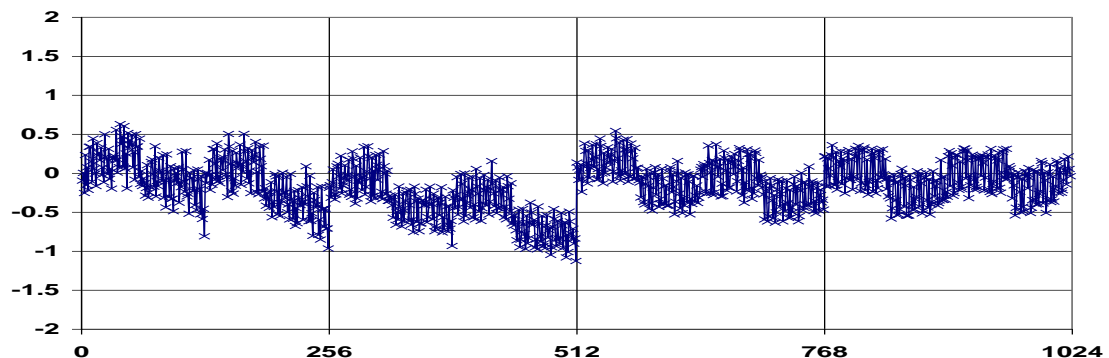

INL [LSB] vs. digital code; 225°C – (external CK)

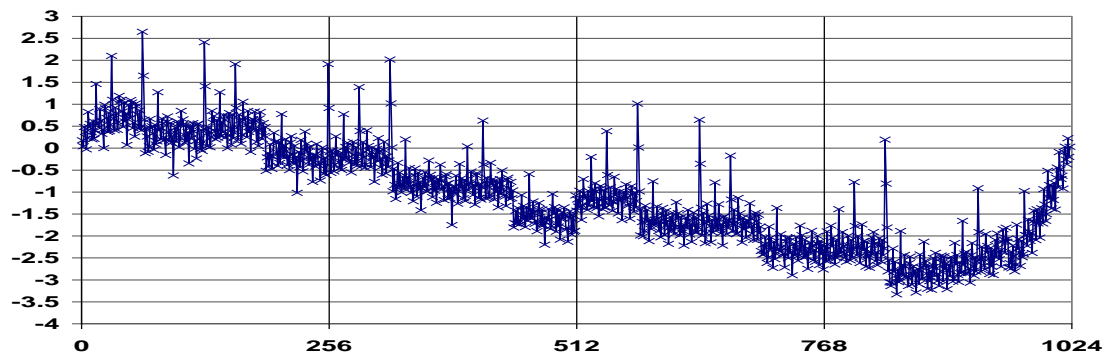

INL [LSB] vs. digital code; 300°C – (external CK)

Figure 2

Typical DNL & INL Characteristics (using internal clock)

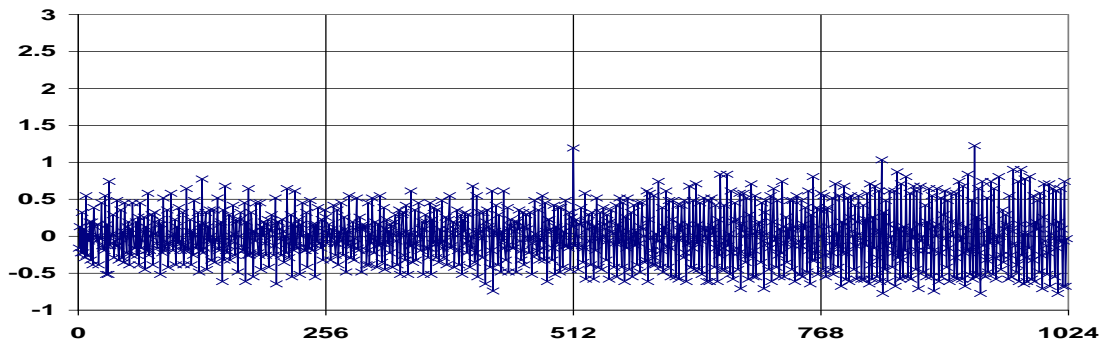

DNL [LSB] vs. digital code; 25°C – (internal CK)

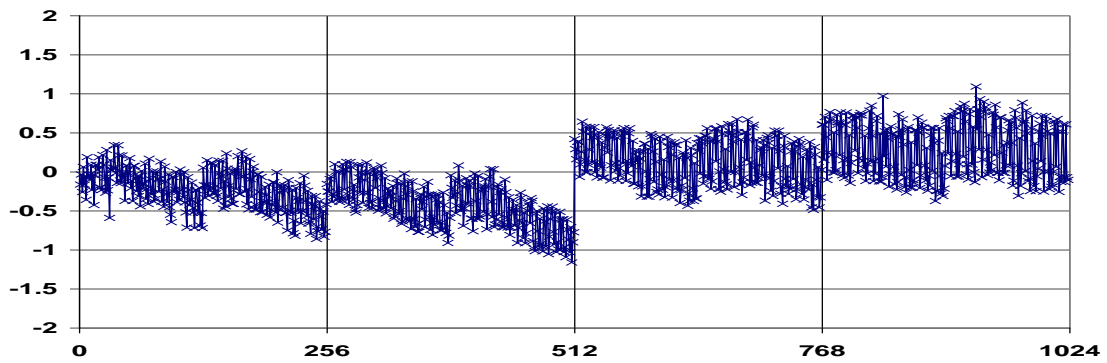

INL [LSB] vs. digital code; 25°C – (internal CK)

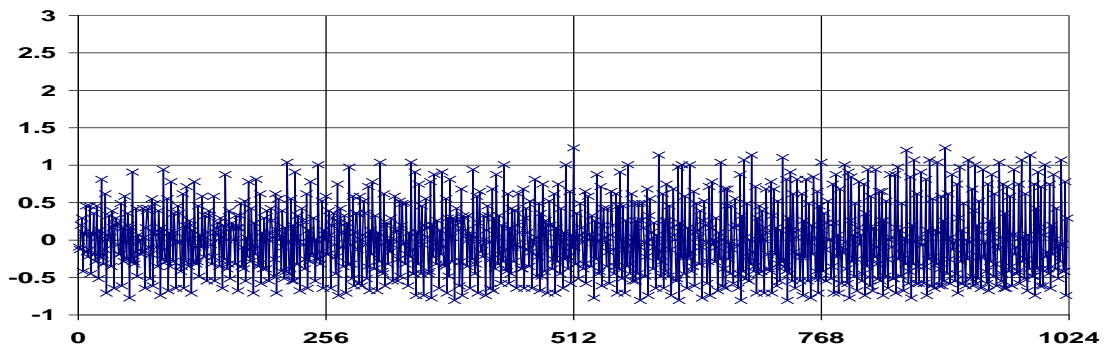

DNL [LSB] vs. digital code; 225°C – (internal CK)

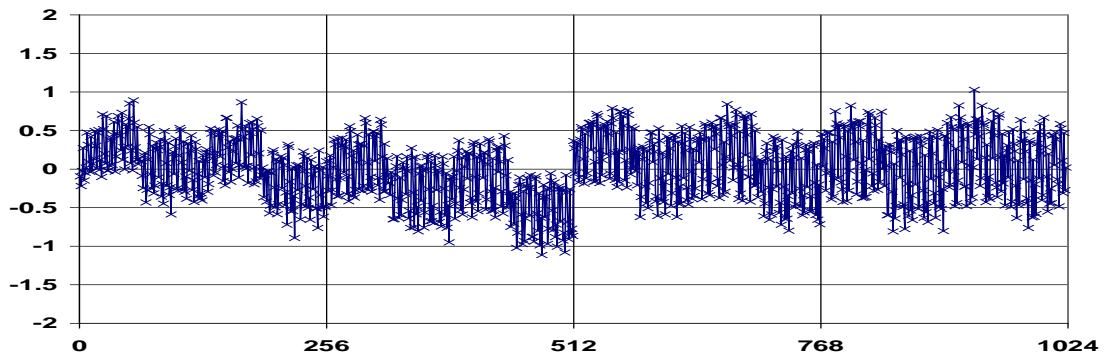

INL [LSB] vs. digital code; 225°C – (internal CK)

Figure 3

Static Characteristics

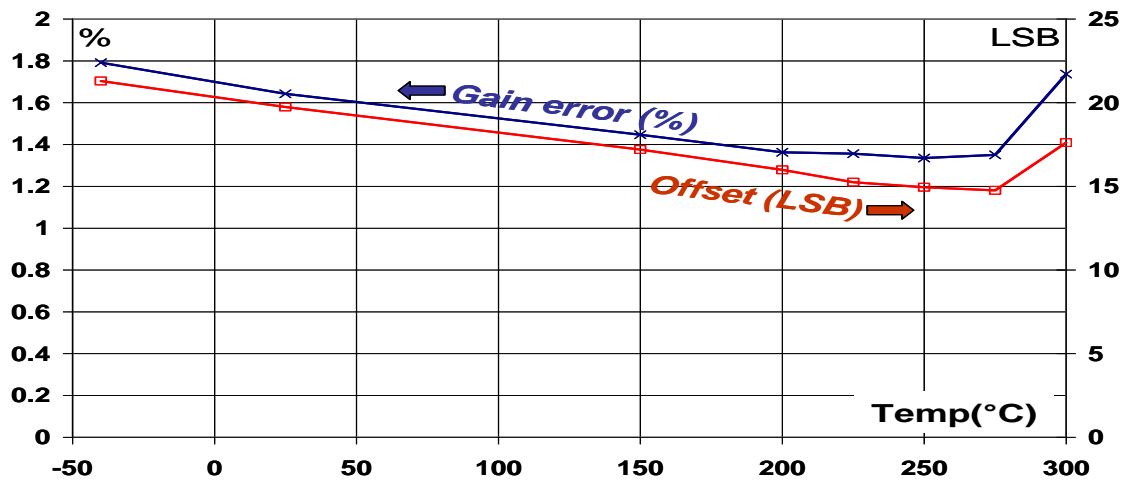

Figure 4: Typical Gain Error (%) and Offset (LSB) over temperature in [0...5]V range.

External CK=200kHz

$$ADC \text{ transfer function is: } D = Offset + A * (1024/5) * (1 - (GainError/100))$$

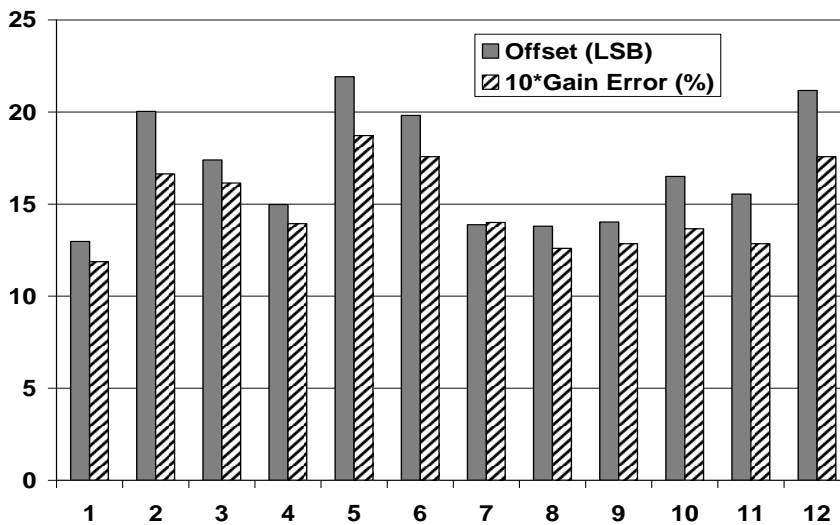

Figure 5: Gain Error (*10) and Offset (LSB) measured at 25°C on 12 samples from 2 different wafer batches. External CK=200kHz.

AC Characteristics

-Internal clock; [0...5]V range, input @1kHz; 4.9V_{pp}.

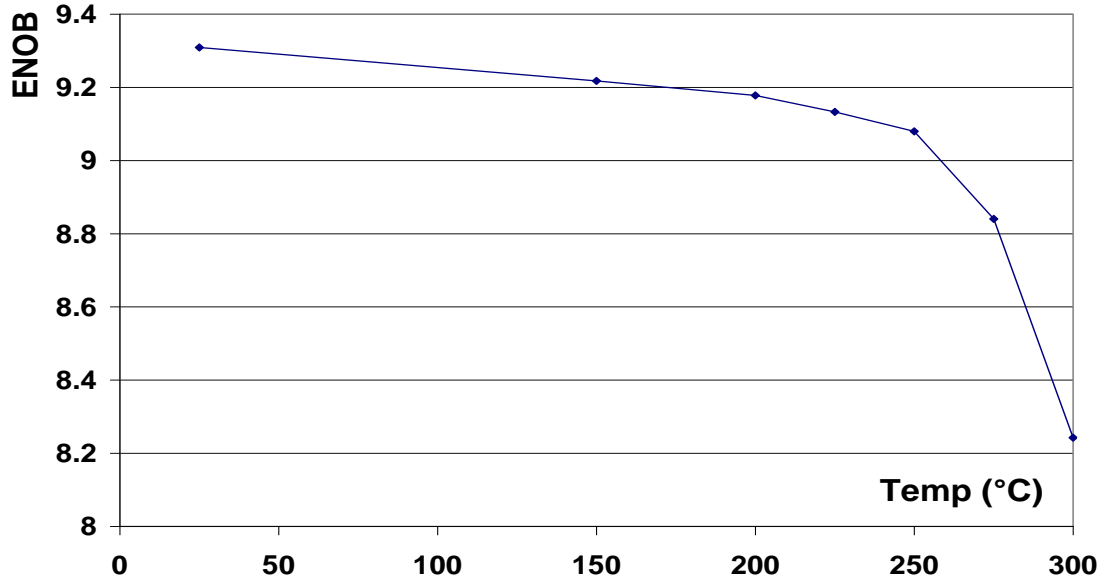

Figure 6: Typical ENOB (=S/(N+D)) over temperature; VDDD=5V

-External clock at 200kHz; [0...5]V range, input @1kHz; 4.9V_{pp}.

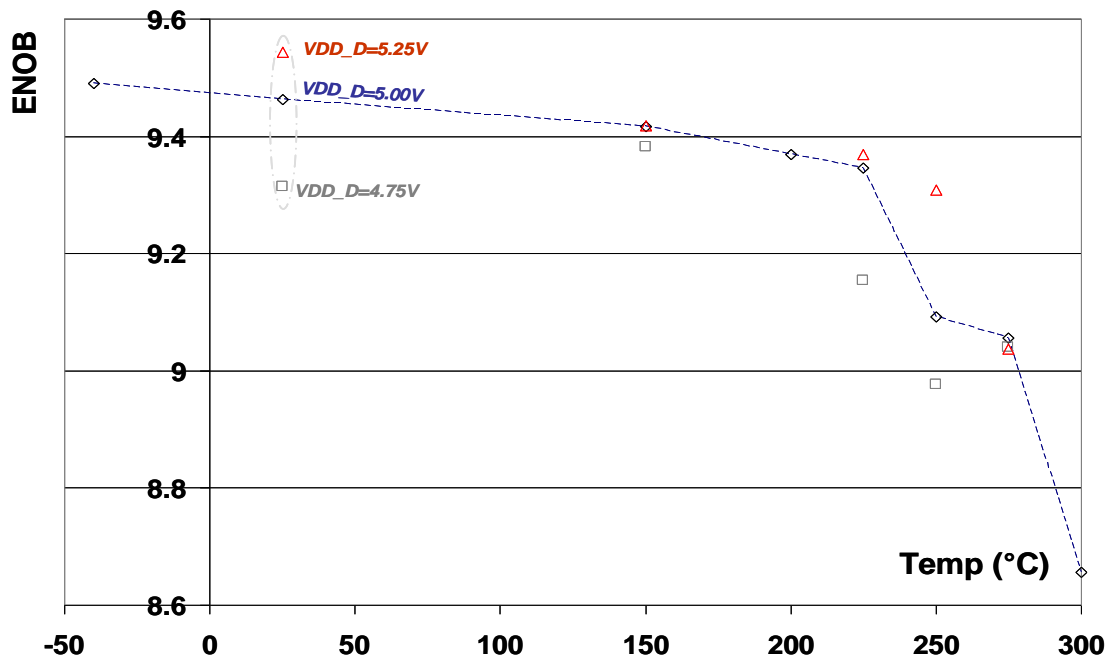

Figure 7: Typical ENOB over temperature; VDDD=4.75V; 5V; 5.25V

AC Characteristics

-External clock; [0...5]V range, input @1kHz; 4.9V_{pp}; V_{DD}=5V

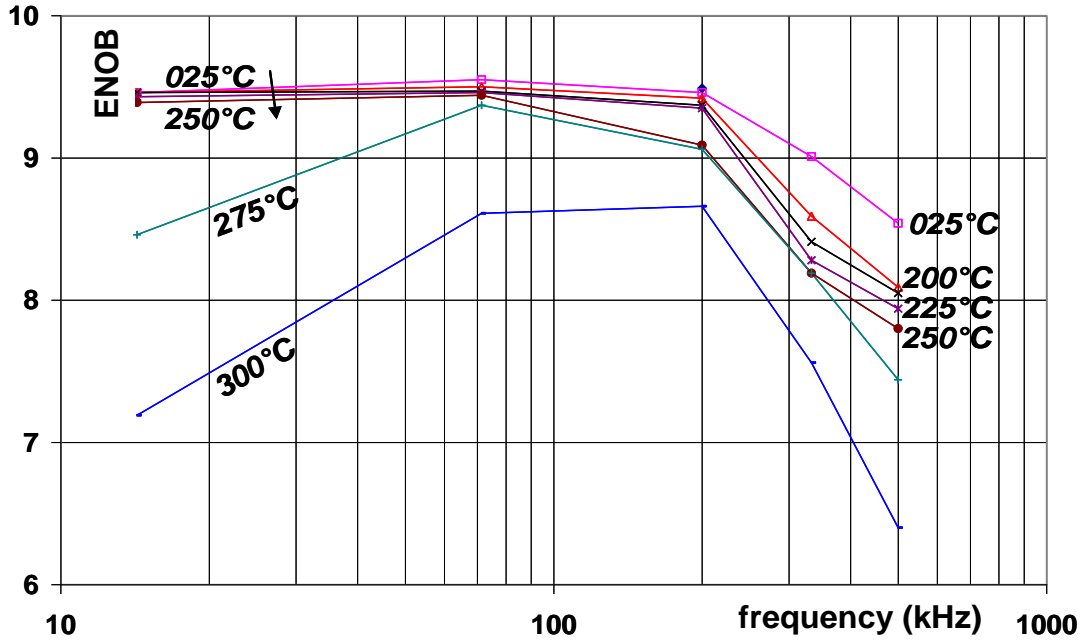

Figure 8: Typical ENOB over Temperature vs. external CK frequency

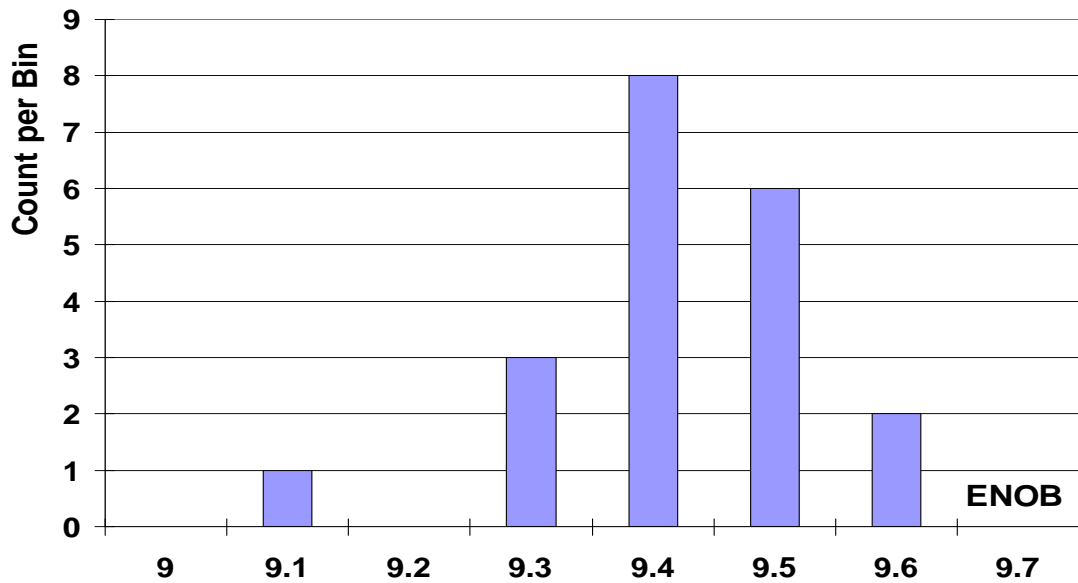
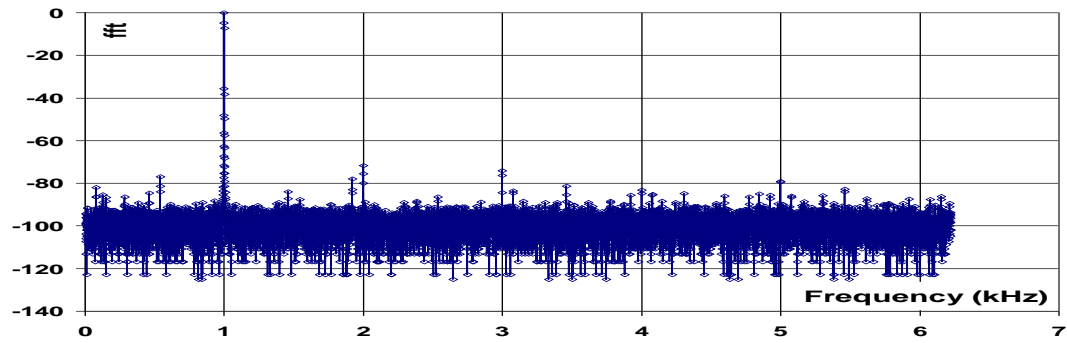

Figure 9: ENOB distribution measured at 25°C on 20 samples from 2 different wafer batches

External CK=200kHz; 13.1kS/s

AC Characteristics

-External clock at 200kHz; [0...5]V range, input @1kHz; 4.9V_{pp}.



Normalized fft (dB) @ -55°C – 12.4kS/s (external CK)

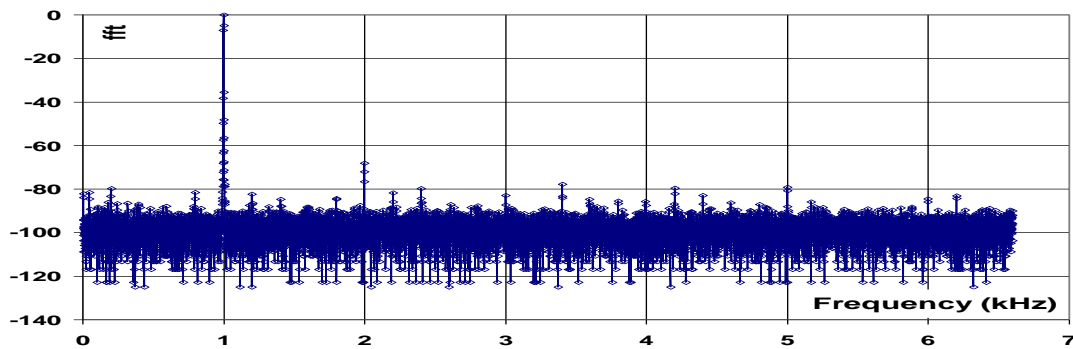

Normalized fft (dB) @ 25°C – 13.1kS/s (external CK)

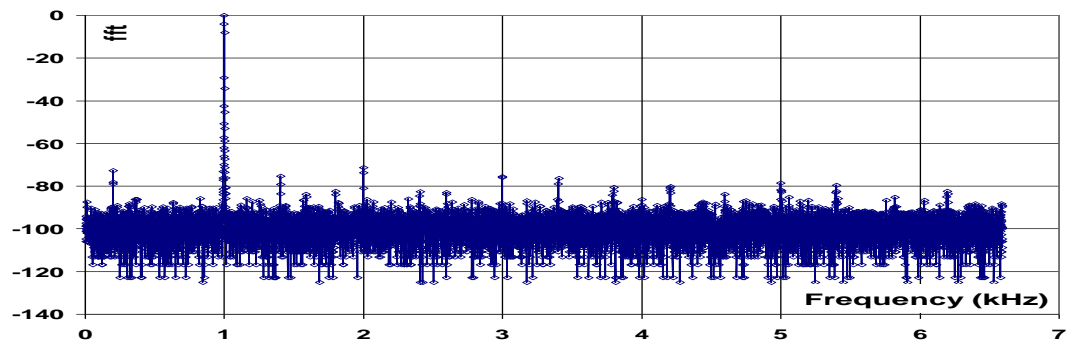

Normalized fft (dB) @ 225°C – 13.1kS/s (external CK)

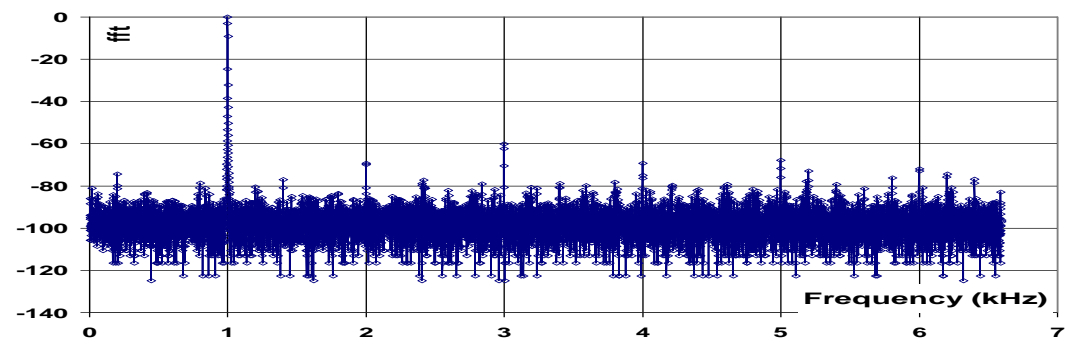

Normalized fft (dB) @ 300°C – 13.1kS/s (external CK)

Figure 10

AC Characteristics

-Internal clock; [0...5]V range, input @1kHz; 4.9V_{pp}.

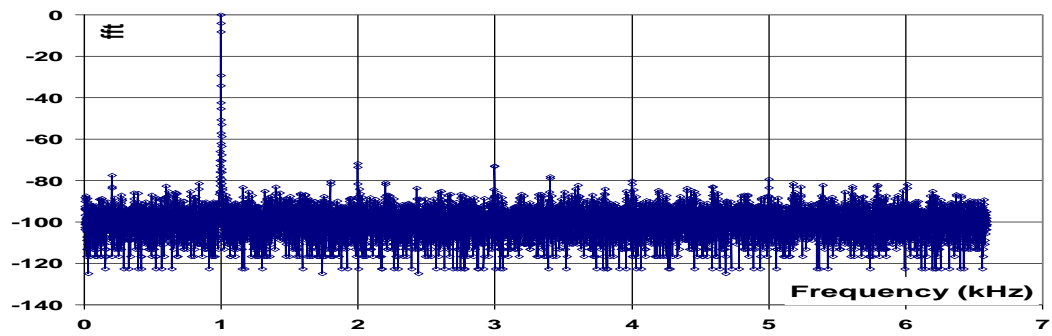

Normalized fft (dB) @ 25°C – 13.1kS/s (internal CK)

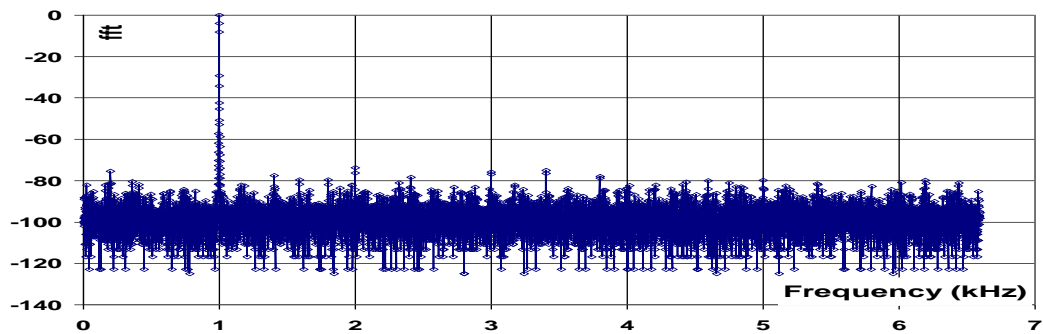

Normalized fft (dB) @ 225°C – 13.1kS/s (internal CK)

Figure 11

Circuit Functionality

Operating conditions

The CHT-ADC10 has been qualified for digital supply voltages from 4.75V to 5.25V and for an accurate and noise-free analog supply voltage of 5V.

The qualification temperature range extends from -55°C to +225°C, though functionality above +250°C is achieved with some derating of the characteristics.

Input scaling

The CHT-ADC10 allows operating with several possible input voltage ranges by properly connecting its 3 analog inputs (Vin_5; Vin_10; Vin_bip). Connecting them to the analog input voltage to be sampled, to Gnd_A or to Vdd_A allows setting different input voltage dynamic ranges. For a standard 0-5V range for example, the analog input is “Vin_5” pin whereas both other pins “Vin_10” and “Vin_bip” must be grounded. For other input ranges, please refer to the **Static Characteristics** table.

Circuit control

The CHT-ADC10 control logic includes standard protocol control signals (nCS, R_nC, CE, A0 and 10_n8) for communication with most μ C. The CHT-ADC10 may operate in full μ C control or in stand-alone mode. Full control protocols for the “conversion” and “read” cycles are shown in the figures below.

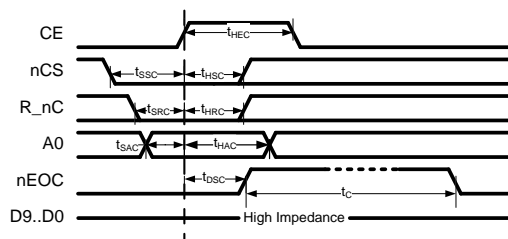

Figure 12. Conversion cycle timing.

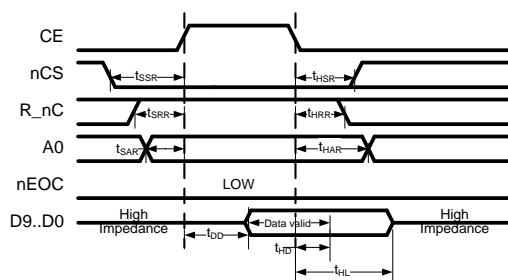

Figure 13. Read cycle timing.

In the stand-alone mode of operation, the converter is controlled only by means of

the control signal R_nC. Signal CE must be connected to Vdd_D and signal nCS must be connected to Gnd_D. Control signals A0 and 10_n8 can be driven as desired or be hardwired according to the final application specifications.

The table below presents all possible operations based on all control lines combination.

CE	nCS	R_nC	10_n8	A0	Operation
0	X	X	X	X	None
X	1	X	X	X	None
↑	0	0	X	0	Initiates a 10-bit conversion
↑	0	0	X	1	Initiates a 8-bit conversion
1	↓	0	X	0	Initiates a 10-bit conversion
1	↓	0	X	1	Initiates a 8-bit conversion
1	0	↓	X	0	Initiates a 10-bit conversion
1	0	↓	X	1	Initiates a 8-bit conversion
1	0	1	1	X	Enables 10-bit output
1	0	1	0	0	Enables 8 MSBs only
1	0	1	0	1	Enables 2 LSBs plus 6 trailing zeroes

Clock source selection

Either an external or the internal clock sources can be used. The external CK input must be grounded if the internal clock is used. If an external clock is used, it is strongly recommended to synchronize this external clock signal with the μ C conversion request in order to avoid switching noise during the sampling period. In this case, CK should be kept “high” during the internal 10 μ s sampling period (see below). The presence of the external clock is automatically detected by an internal block, preventing the internal clock from starting. The external clock should be faster than 10kHz in order to avoid erroneous starting of internal clock. Also, at high temperature, slow clocks can lead to excessive discharge of the sampling capacitor over the conversion time. On the other side, external clocks faster than 500kHz strongly affects the ADC DNL.

Sampling period

The input sampling block includes a monostable set to 10 μ s (+/- 2 μ s). When an external μ C initiates a conversion at time t_0 , the input voltage is sampled on an internal capacitor during 10 μ s. This means that the actual sampling always occurs after a constant delay of 10 μ s after the μ C conversion request. During this 10 μ s sampling period, any noise on supplies should be avoided. If the internal (~250kHz) clock is used, this clock is only activated after this 10 μ s sampling period and delivers only 13 clock periods before going back to sleep-mode. If the serial interface is used, it is also recommended to turn off the external serial clock SCLK during the sampling and conversion periods.

During the 10 μ s sampling period, the "input sampling" block sets its input to 2.5V. This means that input impedance during this time period is about 200k Ω for [0-5V] input range setting. After the 10 μ s sampling period, the input sampling block can be considered as an open circuit, leading to an input impedance of about 400k Ω . Absolute impedance values can change up to 30% over temperature and from lot to lot. This is not critical for the ADC as it is based on ratios between resistors and not on their absolute values.

Conversion cycle

A conversion cycle is started whenever the following logic condition occurs:

$(CE=HIGH)\&(nCS=LOW)\&(R_nC=LOW)$

Conversion start is asserted by the rising edge of the condition above. Once the condition is set, conversion is not restarted provided that there is no new rising edge of the condition.

Depending on the value of A0 at the moment where the conversion start condition is asserted, either a 10bit (A0=LOW) or an 8bit (A0=HIGH) conversion cycle is executed. If an 8-bit conversion cycle is performed, the result is present in the 8 MSBs, with the remaining two LSBs set to zero. The value of A0 is latched with the rising edge of the conversion start condition.

During the conversion cycle, nEOC is HIGH and the parallel output bus is set to high-impedance state. Depending on the value of nCS, the serial data output can be at LOW (nCS=LOW) or high-impedance (nCS=HIGH) state.

Once the conversion cycle has finished nEOC returns to LOW and the conversion result is stored in the internal parallel and serial registers.

Reading output data

Once the conversion cycle ends, data can be read out through either any or both parallel and serial ports. Both parallel and serial output interfaces are always active together and can be used simultaneously. To use the parallel port control signal 10_n8 must be accordingly set. If 10_n8 is HIGH, all 10 output lines are enabled at the same time allowing full data word transfer to a bus of at least 10bits. In this case A0 has no influence on the read data. If 10_n8 is LOW, output data is presented as a two 8-bit words. In this case only the output data bus must be set as in Figure 14. When A0=LOW, the 8 MSBs are presented to the bus. When A0=HIGH, the two remaining ADC LSBs are presented to the two MSBs of the data bus, with trailing zeroes on the 6 LSBs.

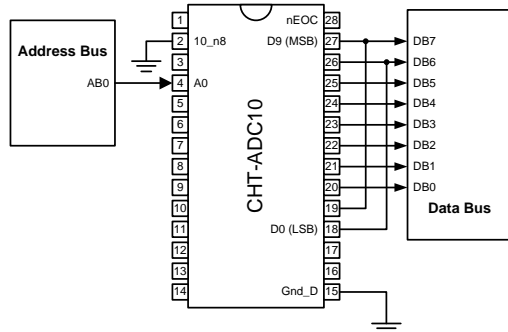

Figure 14. Left-justified 8-bit data bus.

To read the results of a conversion cycle through the serial port, the protocol shown in Figure 15 must be used. The protocol shown initiates a conversion cycled at the end of which the serial interface is used to read the results data.

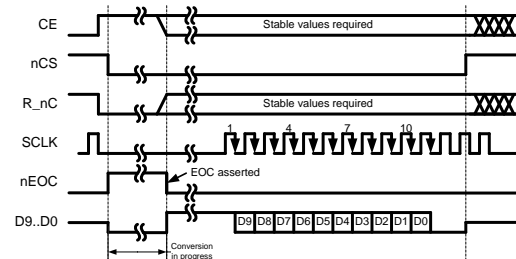

Figure 15. Conversion cycle and serial read protocol.

When using the series interface, SCLK should be stopped during the sampling and conversion periods. Once EOC is asserted, any falling edge on SCLK will produce the series register to shift data out starting by D9 (MSB). Once D0 (LSB) has been shifted out of the register, any SCLK falling edge will continue to shift zeroes out of the series register until nCS returns back to HIGH state. Once a conversion has been finished, any falling edge on nCS reloads the series shift register with the result from the previous conversion as shown in next figure.

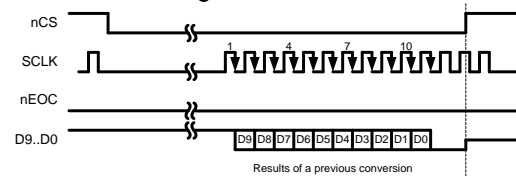
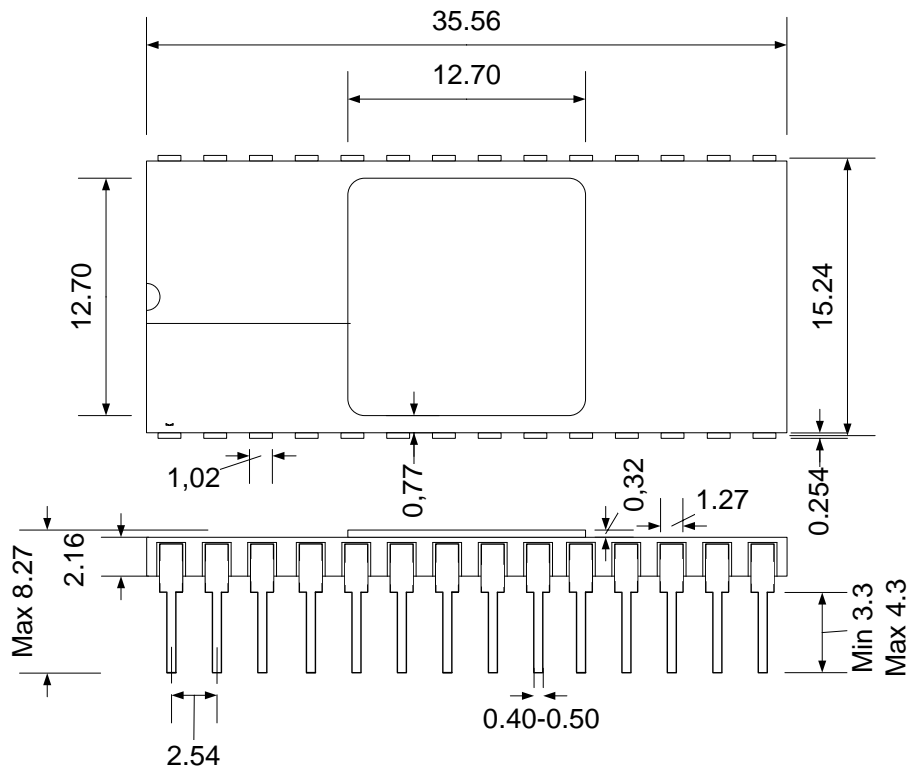
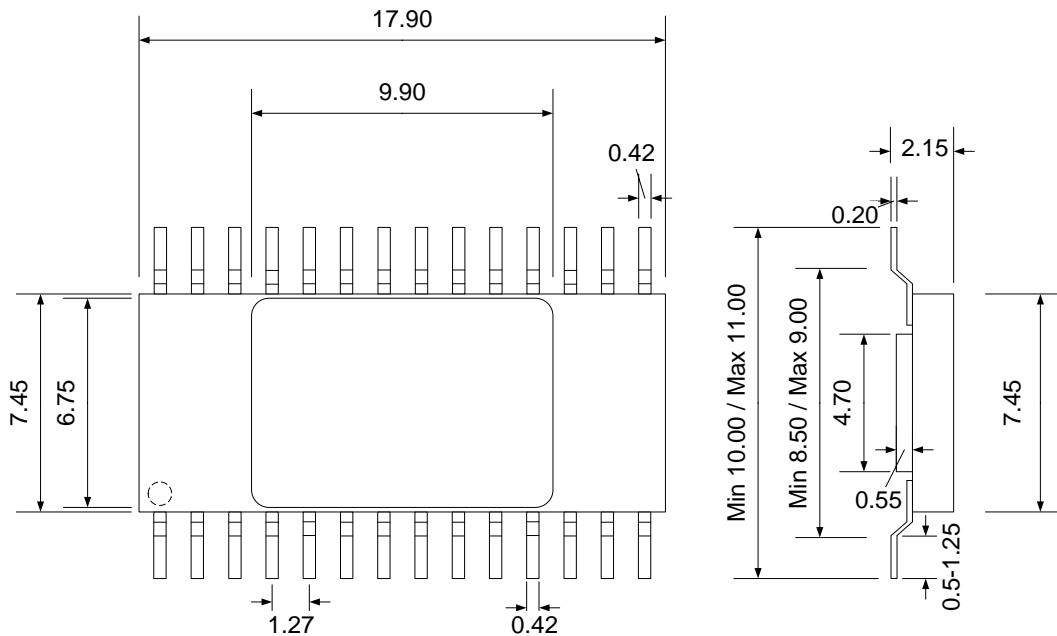

Figure 16. Reloading the results of a previous conversion.

Package Dimensions



Drawing CDIL28 (mm +/-10%)



Drawing CSOIC28 (mm +/-10%)

Contact & Ordering

CISSOID S.A.

Headquarters and contact EMEA:	CISSOID S.A. – Rue Francqui, 11 – 1435 Mont Saint Guibert - Belgium T : +32 10 48 92 10 - F: +32 10 88 98 75 Email: sales@cissoid.com
Sales Representatives:	Visit our website: http://www.cissoid.com

Disclaimer

Neither CISSOID, nor any of its directors, employees or affiliates make any representations or extend any warranties of any kind, either express or implied, including but not limited to warranties of merchantability, fitness for a particular purpose, and the absence of latent or other defects, whether or not discoverable. In no event shall CISSOID, its directors, employees and affiliates be liable for direct, indirect, special, incidental or consequential damages of any kind arising out of the use of its circuits and their documentation, even if they have been advised of the possibility of such a damage. The circuits are provided "as is". CISSOID has no obligation to provide maintenance, support, updates, or modifications.